



COLORADO

Motorcycle Operator's Handbook

PUBLISHED BY THE COLORADO DEPARTMENT OF REVENUE

This Motorcycle Operator's Handbook has been prepared to provide information on the basic knowledge and skills necessary for the safe operation of a 2- or 3-wheel motorcycle.

This handbook is a supplement to the Colorado Driver Handbook. For details on Colorado driving laws, please refer to the Colorado Driver Handbook.

Motorcycling is fun and exciting. There is nothing like seeing the world from behind the handlebars of your own motorcycle, but you need to know safe motorcycle operation skills and behaviors. Unfortunately, many motorcyclists teach themselves or rely on tips from friends. Even after several years of riding, without proper training many do not have the knowledge and skills to avoid a crash.

If you are thinking about buying a 2- or 3-wheel motorcycle for the first time, or if you have been riding for a while, think about motorcycle rider education now!

The Motorcycle Operator Safety Training (MOST) program is designed to prepare you to ride a motorcycle in the safest possible manner. In the Basic Rider Course you will learn motorcycling skills

through on-cycle training as well as in the classroom. The curriculums used have been reviewed and approved by the Colorado Departments of Transportation and Revenue. Visit www.comost.com to locate a MOST training site near you.

This handbook also covers safe operation of a 3-wheel motorcycle. It is important to understand there are differences between 2- and 3-wheel motorcycles. Three-wheel motorcycle rider education is also available in Colorado. The curriculums for 3-wheel motorcycle operation have been reviewed and approved by the Colorado Departments of Transportation and Revenue. In the Novice course, you will learn 3-wheeling skills through classroom instruction as well as instruction on a 3-wheel vehicle.

Keep this handbook for reference even after you have become an endorsed rider and refresh your knowledge occasionally to assure yourself and others that you are a qualified and safe rider.

For the purpose of this handbook, "motorcycle" will refer to both 2- and 3-wheel motorcycles, except where specific notations of 3-wheels are noted.

Cover photo courtesy Tomas Vojtek
www.mindandsoulimages.com

TABLE OF CONTENTS

1. MOTORCYCLE OPERATOR LICENSING	3	12. SPECIAL SITUATIONS.....	13
2. PREPARING TO RIDE.....	3	12.1 Flying Objects	13
2.1 Wear the Right Gear.....	3	12.2 Animals.....	13
2.2 Check the Motorcycle	4	12.3 Getting Off the Road	13
2.3 Become Familiar with the Motorcycle.....	5	12.4 Hills	14
3. CONTROL FOR SAFETY	5	13. CARRYING PASSENGERS AND CARGO.....	14
3.1 Body Position and Posture	5	13.1 Passengers	14
3.2 Turning	5	13.2 Carrying Loads	14
3.3 Braking	6	14. GROUP RIDING	15
3.4 Shifting Gears	6	14.1 Keep the Group Small	15
4. SEE AND BE SEEN.....	6	14.2 Keep the Group Together	15
4.1 Using Your Mirrors.....	7	14.3 Keep Your Distance	15
4.2 Head Checks	7	15. YOUR MOTORCYCLE	15
4.3 Horns	7	15.1 The Right Equipment.....	15
5. LANE POSITION	7	15.2 Motorcycle Care.....	16
6. KEEPING YOUR DISTANCE.....	8	16. MOTORCYCLE OPERATOR SKILLS TEST ...	16
6.1 Distance in Front	8	General Motorcycle Test Course	17
6.2 Distance Behind.....	8		
6.3 Distance to the Side.....	8		
7. SIPDE	9		
8. DANGEROUS SURFACES	9		
8.1 Slippery Surfaces	9		
8.2 Uneven Surfaces and Obstacles	10		
9. RIDING AT NIGHT	11		
10. COLLISION AVOIDANCE	11		
10.1 Quick Stops	11		
10.2 Swerving or Turning Quickly.....	11		
10.3 Riding a Curve	12		
10.4 Cornering.....	12		
11. MECHANICAL PROBLEMS	12		
11.1 Tire Failure	12		
11.2 Stuck Throttle	13		
11.3 Wobble	13		
11.4 Chain Problems.....	13		
11.5 Engine Seizure.....	13		

1. MOTORCYCLE OPERATOR LICENSING

It is illegal for you to operate a motorcycle on a public street or highway in Colorado unless you have a valid license that specifically authorizes the operation of such vehicles. The general motorcycle endorsement "M" qualifies you to ride a 2- or 3-wheel motorcycle. Colorado also issues a separate endorsement "3" that authorizes the operation of 3-wheel motorcycles, only. Low-power scooters (engine size of 50cc or less; or if electric, 4476 watts or less, 40 mph max) do not qualify as motorcycles but Colorado law requires that you have at least a basic driver's license to operate a low-power scooter on public streets.

The State of Colorado no longer issues new "Motorcycle Only" licenses. The motorcycle endorsement will be part of a regular or CDL license, only. The "M" will no longer be issued as a separate class of license.

To add a general or 3-wheel motorcycle endorsement to your existing Colorado driver's license you must be at least 16 years of age and pass all required examinations:

- Driving record review.
- Physical aptitude review.
- Vision test.
- Pass a motorcycle written test (pass the basic written test requirements if you do not have a valid driver's license).
- Pass the motorcycle operator's driving skill test at a State Driver's License Office or with a certified third-party tester. State Driver's License Offices are equipped to test 2/3-wheel motorcycles. If you pass a skills test on a three-wheel motorcycle, the endorsement "3" will appear on your license.
- Pay the required fees.

If you are under 18 years of age, your parent or guardian must sign an Affidavit of Liability and Guardianship for you to be issued your instruction permit. You must hold your motorcycle instruction permit for 12 months and be 16 years of age before you can add the endorsement to your driver's license. If you are between 15 and 16 years of age, you must have completed a Motorcycle Operator Skills Training (MOST) program, and show proof of completion, prior to receiving your instruction permit.

A motorcycle instruction permit allows you to operate a motorcycle while under the immediate, proximate supervision of an adult who is at least 21 years of age and holds a valid COLORADO license endorsed for

motorcycles. If you are under the age of 18, per Colorado Revised Statute 42-2-106, if you are not riding with your MOST instructor or the parent or guardian who signed your Affidavit of Liability, you must have your parent or guardian's permission to ride with another adult who meets the requirements of having a valid driver's license endorsed for motorcycles.

The driving test is the most important part of the examination because it provides you with the opportunity to demonstrate your ability to drive safely. You must provide a properly registered and insured motorcycle to be used in the test. Make certain you are familiar with it and all the controls.

For drivers under 18 years of age, the DR 2324, Drive Time Log Sheet, required for a regular license, is not necessary for the addition of the M or 3 endorsement.

2. PREPARING TO RIDE

As a rider, what you do before you start a trip goes a long way toward determining whether or not you'll get where you want to go safely. Before taking a trip, a safe rider makes a point to:

- Wear the right gear.
- Check the motorcycle equipment.
- Become familiar with the motorcycle.

2.1 WEAR THE RIGHT GEAR: When you ride, your gear is right if it protects you. In any crash, you have a far better chance of avoiding serious injury if you wear:

- An approved helmet.
- Face or eye protection.
- Protective clothing.

HELMET: Crashes are not rare events-particularly among beginning drivers. One of every five motorcycle crashes reported results in head or neck injuries. Head injuries are just as severe as neck injuries, and far more common. Research shows that wearing a helmet reduces your risk of neck or head injury. Colorado Revised Statute 42-4-1502 (4.5) states that a person shall not operate or ride as a passenger on a motorcycle or low-power scooter unless each person under 18 years of age is wearing an approved motorcycle helmet.

An approved helmet lets you see as far to the sides as necessary. A study of more than 900 motorcycle crashes, where 40 percent of the riders wore helmets, failed to find even one case in which a helmet kept a rider from spotting danger.

Most crashes happen on short trips (less than five miles long) just a few minutes after starting out.

Even low-speed crashes can be fatal. Most riders are going slower than 30 M.P.H. when they get hurt. At these speeds, helmets can cut both the number and the severity of head injuries by half.

No matter what the speed, unhelmeted riders are three times more likely to die of head injuries than are riders who are wearing helmets at the time of the crash.

HELMET SELECTIONS: There are two primary types of helmets, providing two different levels of coverage, three-quarter and full face.

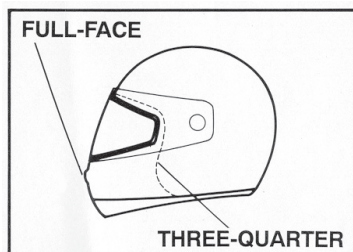

Whichever style you choose, you can receive the most protection out of that type helmet by making sure it meets U.S. Department of Transportation (DOT) standards. Helmets with labels from the American National Standards Institute (ANSI), or the Snell Memorial Foundation give you added assurance of quality. It should fit snugly all the way around and have no obvious defects such as cracks, loose padding, or frayed straps.

Whatever helmet you decide on, make sure to keep it securely fastened on your head when you ride. Otherwise, if you are involved in a crash, the helmet is likely to fly off your head before it has a chance to protect you.

EYE AND FACE PROTECTION: A plastic face shield can help protect your whole face in a crash. The helmet also protects you from wind, dust, dirt, rain, insects, and stones thrown up from cars ahead.

Goggles protect your eyes, but they won't protect the rest of your face the way a face shield does. A windshield is no substitute for a face shield or goggles. Most windshields will not protect your eyes from wind.

Tinted eye protection should not be worn at night or any other time when little light is available.

To be effective, eye or face shield protection must:

- Be free of scratches.
- Be made of shatterproof material.
- Give a clear view to either side.
- Fasten securely, so it does not blow off.

- Allow air to pass through, to reduce fogging.
- Allow enough room for eyeglasses/sunglasses if needed.

EYE PROTECTION FOR MOTORCYCLE OPERATORS AND PASSENGERS IS REQUIRED BY COLORADO LAW 42-4-232 C.R.S.

CLOTHING: Adequate clothing can help protect you in a crash. In cold or wet weather, your clothes should keep you warm and dry, as well as protect you from injury. You cannot control a motorcycle well if you are numb from cold. Riding for long periods in cold weather can cause severe chill and fatigue. A winter jacket should resist wind and fit snugly at the neck, wrists and waist. Good quality rain suits designed for riding resist tearing apart or ballooning up at high speeds.

Jacket and pants should cover your arms and legs completely. They should fit snugly, yet loosely enough to move freely. Leather offers the most protection, but heavy denim does an adequate job in most cases. Sturdy synthetic material provides a lot of protection as well. Wear a jacket even in warm weather. Many jackets are designed to protect you without getting you overheated, even on summer days.

Boots or shoes should be high enough to cover your ankles and sturdy enough to give them support. Soles should be made of hard, durable material. Heels should be short, so they do not catch on rough surfaces. Tuck laces in so they won't catch on your motorcycle.

Gloves give you a better grip and help protect your hands in a crash. Your gloves should be made of leather or heavy cloth.

2.2 CHECK THE MOTORCYCLE: Make a complete check of your motorcycle before you ride.

TIRES: Check the air pressure.

FLUIDS: Oil and fuel levels. Look under the motorcycle for signs of oil and gas leaks.

HEADLIGHT AND TAILLIGHT: Test your dimmer switch to make sure both high and low beams are working.

TURN SIGNALS: Turn on both right and left turn signals. Make sure all four lights flash.

BRAKE LIGHT: Try both controls and make sure each one turns on the brake light.

CLUTCH AND THROTTLE: Make sure they work smoothly. The throttle should snap back when you let go.

MIRRORS: Clean and adjust both mirrors before starting out.

BRAKES: Try the front and rear brake one at a time. Make sure each one feels firm and holds the motorcycle when the brake is fully applied.

HORN: Make sure the horn works.

2.3 BECOME FAMILIAR WITH THE MOTORCYCLE:

Make sure you are completely familiar with the motorcycle before you take it out on the street. Over half the motorcycle accidents occur to riders with less than six months experience on the cycle. If you are going to use an unfamiliar motorcycle:

- Make all the checks you would on your own cycle.
- Find out where everything is, particularly the turn signals, horn, headlight switch, fuel control valve and engine cutoff switch. Make sure you can find and operate them without having to look for them.
- Know the gear pattern. Work the throttle, clutch and brakes a few times before you start riding. All controls react a little differently.
- Ride more cautiously until you become more familiar with the motorcycle.

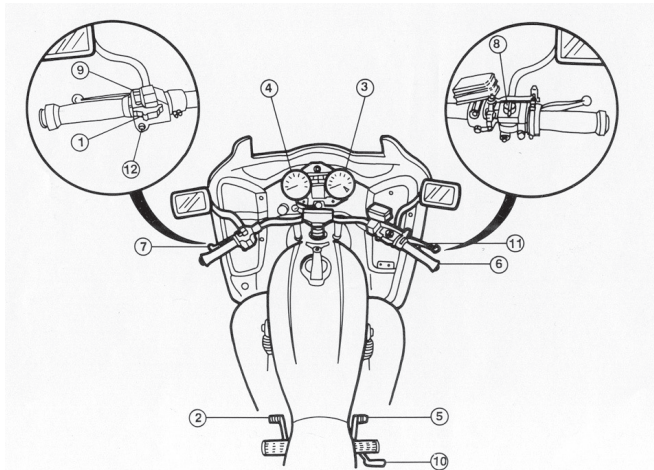

- | | |
|-----------------------|--------------------------|
| 1. Turn-Signal Switch | 7. Clutch Lever |
| 2. Gear-Change Lever | 8. Engine Cut-Off Switch |
| 3. Tachometer | 9. Light Switch |
| 4. Speedometer | 10. Kick Starter |
| 5. Rear Brake Pedal | 11. Front Brake Lever |
| 6. Throttle | 12. Horn Button |

3. CONTROL FOR SAFETY

This manual cannot teach you how to control direction, speed or balance. That's something you can learn only through practice. Control begins with knowing your abilities and riding within them and the rules of the road.

3.1 BODY POSITION AND POSTURE: Sit far enough forward with your arms slightly bent when you hold

the handle grips so that you can use your arms to steer the motorcycle rather than hold yourself up. Bending your arms lets you turn the handlebars without having to stretch.

HANDS: Hold the handle grips firmly. Keep your grip over rough surfaces. Start with your right wrist down. This will help you keep from accidentally using too much throttle - especially if you need to reach for the brake suddenly. Also, adjust the handlebars so your hands are even with, or below your elbows. This allows you to use the proper muscles for precision steering.

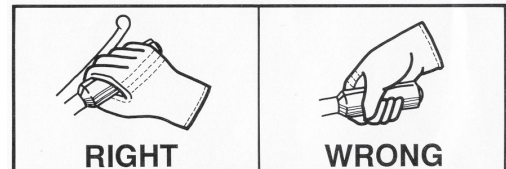

KNEES: Keep your knees against the gas tank. This will help you keep your balance as the motorcycle turns. This is not necessary on a 3-wheel motorcycle.

FEET: Keep your feet firmly on the foot pegs to maintain balance. Don't drag your feet. If your foot catches on something, you could lose control of the motorcycle. Keep your feet near the controls so you can get to the controls quickly if needed. Also, don't let your toes point downward - they may get caught between the road and foot peg.

BASIC 3-WHEEL VEHICLE CONTROL: Tipover lines. It is possible when operating a 3-wheeler to have only two wheels contacting the ground. This condition exists whenever enough weight is transferred outside what are known as "tipover lines." The figure below illustrates the tipover line on trikes and sidecar-equipped motorcycles.

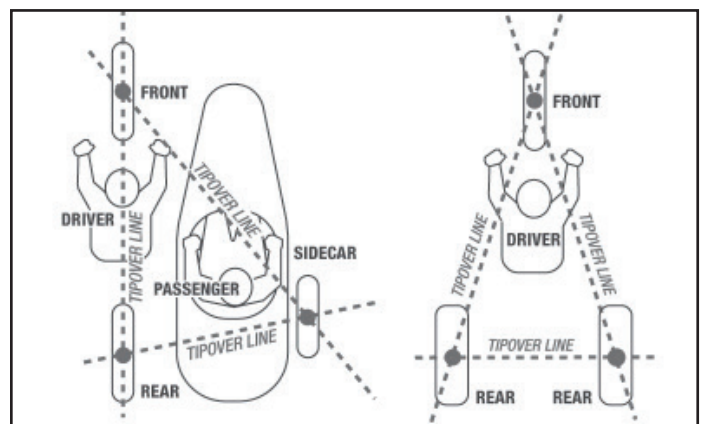

3.2 TURNING: Riders often try to take curves or turns too fast. When they can't hold the turn, they end up crossing into another lane of traffic or going off the road, or they overreact and brake too hard causing a skid and loss of control. Until you learn to judge how

fast you can safely take a curve, approach all turns with caution. Use the following four steps for better control: SLOW, LOOK, LEAN, ROLL.

SLOW: Reduce speed before the turn by closing the throttle and, if necessary, applying both brakes.

LOOK: Look through the turn to where you want to go. Turn just your head, not your shoulders and keep your eyes level with the horizon.

LEAN: To turn, the motorcycle must lean. To lean the motorcycle, push on the handgrip in the direction of the turn. Press left, lean left, go left. Press right, lean right, go right.

In normal turns, the rider and motorcycle should lean together. In slow tight turns, lean the motorcycle only and keep your body straight. Higher speeds and/or tighter turns require more lean.

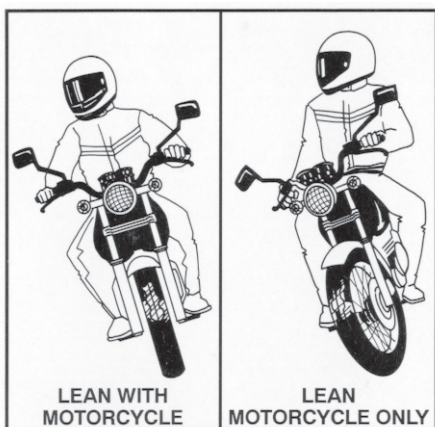

Unique to a 3-wheel motorcycle is the need to adjust your upper body position during cornering. It is necessary to lean in the direction you intend to turn to avoid raising the inside wheel and, possibly, flipping over. Leaning like this is sometimes referred to as “hanging off.” This will be very important with a sidecar-equipped motorcycle if the sidecar has no weight in it.

ROLL: Roll on the throttle through the turn. Maintain steady speed or gradually accelerate. Avoid deceleration while in the turn.

Three-wheel motorcycles CAN tip over. To turn a 3-wheel motorcycle, you point the front wheel in the direction you want to go, lean your body into the turn, roll on the throttle to pull the 3-wheeler through the turn. On a sidecar outfit, when accelerating, compensate for yaw by steering towards the left. When decelerating, compensate for yaw by steering to the right. Yaw is veering to the left or the right.

3.3 BRAKING: Your motorcycle has two brakes, one for the front wheel and one for the rear wheel(s).

Some sidecar rigs also have a brake on their wheel. Use both brakes at the same time. The front brake on a 2-wheel motorcycle and on a sidecar rig provides the most power, while the rear brake provides the most power on a trike. The front brake is safe to use if you use it properly.

Apply both brakes at the same time. Using both brakes for even “normal” stops will permit you to develop the proper habit or skill of using both brakes in an emergency. To completely stop a motorcycle, roll off the throttle, apply the brakes and squeeze the clutch.

When leaning the motorcycle, some of the available traction is used for cornering. So if you use the brakes when leaning, less traction is available for stopping. A skid can occur when too much brake is applied. Some motorcycles have integrated braking systems which link the front and rear brakes together by applying the rear brake pedal. Using the front brake incorrectly on a slippery surface may be hazardous.

3.4 SHIFTING GEARS: Learning to use the gears correctly when downshifting, turning, or starting on hills is important for safe motorcycle operation.

Shift down through the gears as you slow down or stop. Remain in first gear while you are stopped so you can move out quickly if you need to.

Make certain you are going slowly enough when you shift into a lower gear. If not, the motorcycle will lurch and the rear wheel may skid. When riding downhill or shifting into first gear, you may need to use the brakes to slow down enough to downshift slowly.

It is best to change gears before entering a turn, however, sometimes shifting in a turn is necessary. If so, remember to do so smoothly. A sudden change in power to the rear wheel can cause a skid.

4. SEE AND BE SEEN

A motorcycle's outline is much smaller than a car's outline. In crashes with motorcyclists, car drivers often say that they never saw the motorcycle. You can do many things to make it easier for others to recognize you and your cycle.

CLOTHING: Most crashes occur in daylight. Wear bright clothing to increase your chances of being seen. Remember, your body is half the visible surface area of the rider/cycle unit.

Bright orange, yellow or green jackets, or vests are your best bets for being seen. Your helmet can do more than protect you in a crash. Brightly colored helmets or reflective material can help others see you.

HEADLIGHT: The best way to help others on the road see your motorcycle is to keep the headlight on at all times. Use of the high beam in daylight increases the likelihood that you will be seen by oncoming drivers.

SIGNALS: Use your signals anytime you plan to turn, change lanes, or when using a freeway entrance/exit ramp. Use them even when you think no one else is around or even when what you plan to do is obvious. Once you've made your lane change or turn, check your signal to make sure it is off.

BRAKE LIGHT: Your motorcycle's brake light is usually not as noticeable as the brake lights on a car. Help others notice you by flashing the foot brake lightly before you slow down, especially, when slowing more quickly than others expect (e.g. turning off a highway, turning into driveways, when others are following too closely).

4.1 USING YOUR MIRRORS: While it's most important to keep track of what's happening ahead, you can't afford to ignore situations behind. Frequent mirror checks should be part of your normal scanning routine. Make a special point of using your mirrors in these situations:

- When you are stopped at an intersection, watch cars coming up from behind. If the driver isn't paying attention, he could be right on top of you before seeing you.
- Before you change lanes make sure no one is about to pass you.
- Before you slow down, check to see if the driver behind expects to slow or if he may be unsure about exactly where you will slow. For example, he might see you turn and think you plan to slow for a turn at a distant intersection, rather than a nearby driveway.

Many motorcycles have rounded convex mirrors. These give you a wider view of the road behind than do flat mirrors. They also make cars seem farther away than they really are. Practice with your mirrors until you become a good judge of distance.

4.2 HEAD CHECKS: Motorcycles have blind spots like cars. Before you change lanes, turn your head and look at traffic to the side to spot a car about to pass you.

On a road with several lanes, make sure to check the far lane as well as the one next to you. A driver in the far lane may head for the same space you plan to take.

4.3 HORNS: Be ready to use your horn whenever you need to get someone's attention. It is a good idea to

give a quick beep before you pass anyone you think may move into your lane. In an emergency, press the horn button loud and long. Be ready to stop or swerve from the danger. Here are some situations:

- A driver in the lane next to you is getting too close to the vehicle ahead and may want to pass.
- A driver opening a door on a parked car.
- Someone is riding a bicycle or walking in the street.

5. LANE POSITION

You can make the size of the motorcycle work to your advantage. A car driver has very little choice about where he positions his car in a lane. However, each marked lane gives a motorcyclist three possible paths of travel as indicated in the diagram. Remember, 3-wheeled vehicles are larger than 2-wheel motorcycles and require more space in a lane, similar to an automobile.

In general, there is no best position for riders to be seen. Ride where it will be easiest for drivers to see you. No portion of the lane need be avoided - including the center. Unless the road is wet with rain, even the average oily strip gives enough traction to ride safely.

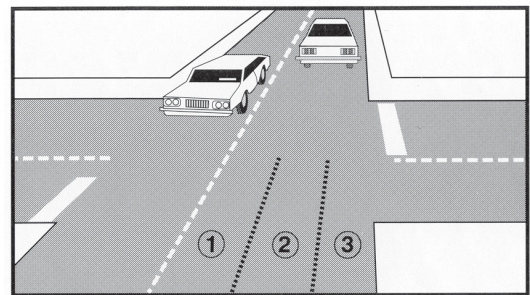

Do not ride next to cars or trucks in other lanes if you do not have to. A car in the next lane could switch into your lane without warning. Do not ride in other vehicle's blind spots. Either pass the other vehicle or drop back.

Let the driver ahead see you. When behind a car, try to ride where the driver can see you in his rearview mirror. Riding in the center portion of the lane should put your image in the middle of the rearview mirror, where it's most likely to be seen. Riding

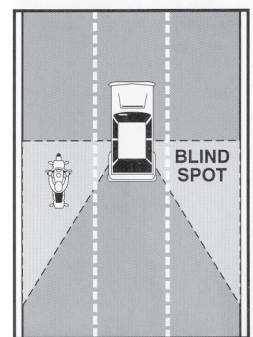

at the far side of a lane may let you be seen in a side view mirror. But most drivers don't look at their side view mirrors nearly as often as they check the rearview mirror.

As a motorcycle rider, you can put yourself in a position to see things that a car driver cannot see.

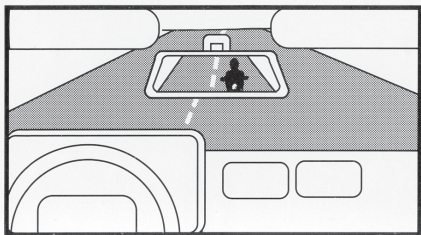

CURVES: You can move from one portion of a lane to another to get a better view through a curve. Moving to the center portion of your lane before a curve, and staying there until you come out of the curve, lets you spot traffic coming toward you as soon as possible. This also allows you to adjust for traffic that is crowding the center line or for debris that is blocking part of your lane. With a 3-wheel motorcycle on a curve, follow a path of travel that makes the most gradual turn.

ROADSIDE: Angle your motorcycle so that you can see in both directions without straining and without having any part of the cycle in the lane of travel. A clear view in both directions is particularly important if you plan to turn across a lane of traffic.

6. KEEPING YOUR DISTANCE

The best protection you can have is distance, a cushion of space - all around your cycle. If someone else makes a mistake, distance gives you time to react and room to maneuver.

6.1 DISTANCE IN FRONT: Usually motorcycles do not need as much distance to stop as do cars. Use the two second following rule as a guide. This leaves you enough time to stop or swerve if the driver ahead of you stops suddenly. It also gives you a better view of potholes and other dangers in the road.

In some situations, you should open up a three-second following distance. This larger cushion of space is needed if your motorcycle will take longer than normal to stop (i.e. if the pavement is slippery with rain) or if you cannot see around the vehicle ahead.

Keep well behind the vehicle ahead even when you are stopped. This will make it easier to get out of the way if someone bears down on you from behind. It will also give you a cushion of space if the vehicle ahead starts to back up for some reason.

6.2 DISTANCE BEHIND: If someone tailgates you, don't try to lose them by speeding up. You'll just end up being tailgated at a higher speed.

A better way to handle tailgaters is to get them in

front of you. When someone is following too closely, change lanes and let them pass. If you can't do this, slow down and open up extra space ahead of you. This will encourage them to pass. If they don't pass, you will have given yourself and the tailgaters more time and space to react in case an emergency does develop.

6.3 DISTANCE TO THE SIDE: By shifting from one portion of a lane to another you can keep a safe cushion of space on both sides. An experienced rider changes position within the lane as traffic conditions change. Here are some conditions that require changes in lane position.

PASSING:

- Ride in the left portion of the lane at a safe following distance to increase your line of sight and make you more visible. Signal and check for oncoming traffic. Use your mirrors and turn your head to look for traffic behind.

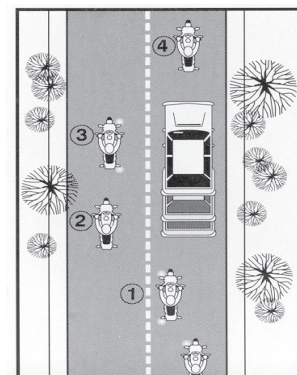

- Move into the left lane and accelerate. Select a lane position that doesn't crowd the car you are passing and provides space to avoid hazards in your lane.
- Ride through the blind spot as quickly as possible.
- Signal again, and complete mirror and head checks before returning to your original lane.

****Remember, passing must be completed within posted speed limits, and only where permitted.**

BEING PASSED: When you are being passed from behind or by an oncoming vehicle, stay in the center portion of your lane. Do not move into the portion of the lane that is furthest from the passing vehicle. It might invite the other driver to cut back into your lane too early. If you ride any closer to them, you could be hit by the other vehicle, something thrown from the windows, extended mirrors, or blasts of wind from large vehicles.

PARKED CARS: When passing parked cars, stay toward the left of your lane. You can avoid problems caused by doors opening, drivers getting out of cars, people stepping from between cars and cars pulling away from the curb. A car making a sudden U-turn may cut you

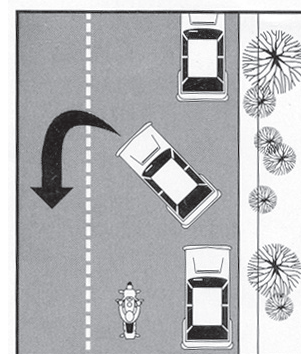

off entirely, blocking the whole roadway and leaving you with no place to go.

LANE SHARERS: Cars and motorcycles need a full lane to operate safely. Don't ride between rows of stopped cars in the same lane. Discourage lane sharing by riding in a center lane position whenever other drivers might be tempted to squeeze by you. Drivers are most tempted to do this in heavy traffic, when passing, when you are preparing to turn and at freeway entrance and exit ramps.

MERGING CARS: Drivers on an entrance ramp may not see you on the highway. Give them plenty of room. Change to another lane, if it is open. If there is no room for a lane change, adjust speed accordingly to open up space for the merging driver to pull into.

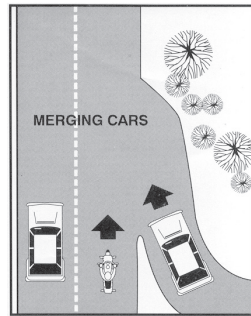

7. SIPDE

Good experienced riders remain aware of what is going on around them. They improve their riding strategy by using Scan, Identify, Predict, Decide and Execute (SIPDE). This is a five-step process used to make judgments and take action in traffic.

SCAN: Search aggressively ahead, to the sides and behind to avoid potential hazards. Scanning provides you with the information you need to make your decisions in enough time to take action.

IDENTIFY: Locate hazards and potential conflicts. The hazards you encounter can be divided into three groups based on how critical their effect on you may be.

- Vehicles and other motorcycles: May move into your path and increase collision impact.
- Pedestrians and animals: Are unpredictable and make short quick moves.
- Stationary objects: Potholes, guard rails, bridges, roadway signs, hedges, or rows of trees won't move into your path, but may influence your riding strategy.

PREDICT: Consider space and direction of a potential hazard. Anticipating a vehicle moving away from you is not as critical as a vehicle moving into your path.

Predict where a collision might occur. This is the "What if...?" phase of SIPDE that depends on your knowledge and experience.

DECIDE: Decide when, where, and how to act based

on types of hazards you encounter:

- Single Hazard
- Stationary
- Multiple Hazards
- Moving

EXECUTE: In high potential risk situations, such as intersections, cover the clutch and both brakes to reduce the time you need to react. To create more space and minimize risk from any hazard:

- Communicate your presence with lights and/or horn.
- Adjust your speed by accelerating, stopping or slowing.
- Adjust your position and/or direction.

Most motorcycle/automobile collisions occur at intersections. An intersection can be anywhere other traffic may cross your path of travel. Your use of SIPDE at intersections is critical.

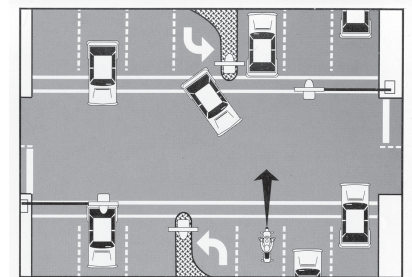

Be especially alert at intersection with limited visibility. Be aware of visually busy surroundings that could camouflage you and your motorcycle.

8. DANGEROUS SURFACES

Your chance of falling or being involved in a crash increases whenever you ride across slippery surfaces, uneven surfaces or obstacles, railroad tracks, grooves and gratings.

8.1 SLIPPERY SURFACES: Motorcycles handle better when ridden on surfaces with good traction. Surfaces that provide poor traction include:

- Wet pavement, particularly just after it starts to rain and before surface oil washes to the side of the road.
- Gravel roads, or where sand and gravel collect.
- Mud, snow, and ice.
- Lane markings, steel plates and manhole covers, especially when wet.

To ride safely on slippery surfaces:

- **REDUCE SPEED:** Slow down before you get to a slippery surface to lessen your chances of skidding. It is particularly important to reduce speed before entering wet curves.
- **AVOID SUDDEN MOVES:** Any sudden change in

speed or direction can cause a skid. Be as smooth as possible when you speed up, shift gears, turn or brake.

- **USE BOTH BRAKES:** The front brake is still more effective than the rear brake, even on a slippery surface. Apply it gradually and avoid locking up the front wheel.

The center of a lane can become dangerous when wet. When it starts to rain, ride in the tire tracks left by cars. Often the left tire track will be the best position, depending on traffic and other roadway conditions. Watch for oil spots when you put your foot down to stop or park. You may slip and fall.

Dirt and gravel collect along the sides of the road - especially on curves and ramps leading to and from highways. Stay away from the edge of the road, particularly when making sharp turns at intersections and when getting on or off freeways at high speed. Rain dries and snow melts faster on some sections of a road than on others. Ride in the least slippery part of the lane at all times.

VERY SLIPPERY SURFACES: Cautious riders steer clear of roads covered with ice or snow. You may find yourself on a road with scattered patches or ice or snow. Patches of ice tend to develop in low or shaded areas and on bridges and overpasses. If you encounter wet surfaces or wet leaves in the fall, these are just as slippery as an ice patch.

Avoid all of these surfaces if at all possible. If you can't, keep your bike straight up and proceed as slowly as possible, letting your feet skim along the surface so you can catch yourself if the bike starts to fall. Be sure to keep off the brakes and squeeze the clutch and coast while you are on a very slippery surface.

An advantage of a 3-wheel motorcycle over a 2-wheel motorcycle is the inherent stability. A 3-wheel motorcycle can slide sideways without falling down, similar to an automobile. Slick pavement, unpaved roads or off-road situations are quite manageable on a 3-wheel motorcycle.

8.2 UNEVEN SURFACES AND OBSTACLES: Watch for uneven surfaces such as bumps, broken pavement, potholes. If you have to ride over them, or obstacles such as a piece of tire tread or tailpipe, slow down to reduce the jolt, make sure the motorcycle is straight up and rise slightly off the seat with your weight on the foot pegs so you can absorb the shock with your knees and elbows.

Rising off the seat will cut your chances of being thrown off the bike. However, controlling the throttle can be somewhat tricky. Practice this technique in a safe area (such as a deserted parking lot) before you try to do it on-street.

If you ride over an object on the street, pull off the road and check your tires and rims for damage before going any further.

RAILROAD TRACKS: A motorcycle can cross tracks at an angle as sharp as 45 degrees without difficulty. Changing your course to take tracks head-on can be more dangerous than crossing at an angle (It may carry you into another lane of traffic).

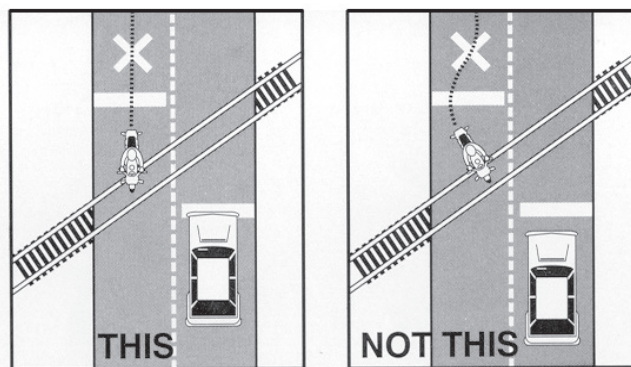

You do need to change direction, however, to cross something that runs in the same direction you are going. For example, you may wish to cross trolley tracks, ruts in the middle of the road, or pavement seams that run parallel to your course.

To cross these safely, move far enough away to be able to cross them at an angle as close to 90 degrees as possible. Then, make a quick, sharp turn across. Do not try to edge across. The tracks or seam could catch your tires and throw you off balance.

GROOVES AND GRATINGS: Riding over rain grooves or metal bridge gratings will cause the motorcycle to weave. It's an uneasy feeling, but it's generally not dangerous. Relax, stay on course, maintain speed, and ride straight across. Trying to cross these surfaces at an angle may reduce the uneasy feeling, but it also forces the rider to zigzag to stay in the lane. The zigzag is far more dangerous than the weaving feeling.

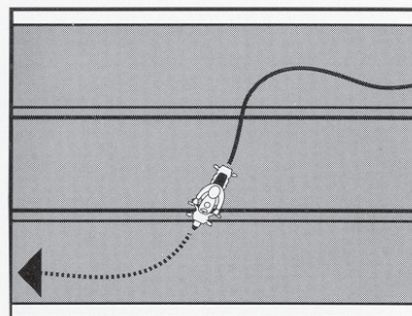

9. RIDING AT NIGHT

At night it is harder for you to see and be seen. Other drivers may have a hard time picking your headlight or taillight out of the greater number of car lights around you. To compensate you should:

REDUCE YOUR SPEED: Ride more slowly at night than you would during the day, particularly on roads you don't know well.

INCREASE DISTANCE: Distances are harder to judge at night than day. Your eyes rely upon shadows and light contrasts to judge both how far away an object is and how fast you are approaching. These contrasts are missing or distorted under the artificial light at night. Open up a three-second following distance. Allow more distance in which to pass.

USE THE CAR AHEAD: The headlights of the car ahead can give you a better view of the road ahead than even your high beam can. Taillights bouncing up and down can alert you to bumps or rough pavement.

USE YOUR HIGH BEAM: Get all the light you can. Use your high beam whenever you are not following or meeting a car.

LANE POSITION: Be flexible about lane position, changing to whatever portion of the lane is best able to help you see, be seen, and keep an adequate space cushion.

10. COLLISION AVOIDANCE

No matter how careful you are, there will be times when you find yourself in a tight spot. Your chances of getting out safely depend upon your ability to react quickly and properly.

Knowing when and how to stop or swerve are two skills critical to avoiding a collision. It is not always desirable or possible to stop quickly to avoid an obstacle. Riders must also be able to swerve around an obstacle. Determining the skill necessary for the situation is important as well.

Studies show that most collision-involved riders under brake the front tire and over brake the rear tire and swerve at the same time.

10.1 QUICK STOPS: To stop quickly, apply both brakes at the same time. Don't be shy about using the front brake, but don't 'grab' at it, either. Squeeze the brake lever steadily and firmly, applying the front brake as fully as you can without locking the front wheel. At the same time, apply the rear brake hard, without locking it.

If you are on a straight-away, even with a locked rear wheel, keep it locked until you have completely stopped. Even with a locked rear wheel, you can control a 3-wheel motorcycle on a straightaway *if it is going in a straight line*. Hard braking in a straight line is less likely to result in a tipover. If you must stop quickly while turning or riding in a curve, conditions may not always permit you to straighten up the motorcycle and then stop. Apply the brakes and start slowing the motorcycle. As you slow down, you can reduce your lean angle and apply more brake pressure until the motorcycle is straight and maximum brake pressure is possible. If you straighten the handlebar in the last few feet of stopping, you know the motorcycle will be straight up and in balance.

10.2 SWERVING OR TURNING QUICKLY: Sometimes, you may not have enough room to stop, even if you use both brakes properly. An object might appear suddenly in your path or the car ahead might suddenly stop. The only way to avoid a collision would be to turn quickly, swerve, or ride over the obstacle.

A swerve is any sudden change in direction. It can be two quick turns, or a rapid shift to the side. Apply a small amount of hand pressure to the handgrip in your intended direction of escape. This will cause the motorcycle to lean quickly. The sharper the turn(s), the more the bike must lean.

Keep your knees against the tank and your feet solidly on the pegs. Let the bike move underneath you. Make your escape route the target of your vision. Press on the opposite handgrip, once you clear the obstacle to return to your original direction of travel. To swerve to the left, press left, then right to recover. To swerve to the right, press right, then left.

Try to stay in your own lane. Change lanes only if you have enough time to make sure there are no vehicles in the other lane. You should be able to squeeze by most obstacles without leaving your lane.

If braking is required, separate it from swerving. Brake before or after, never while swerving. On a 3-wheel motorcycle, you should be leaning your body into corners normally; this may help to avoid a rollover when swerving with an empty sidecar.

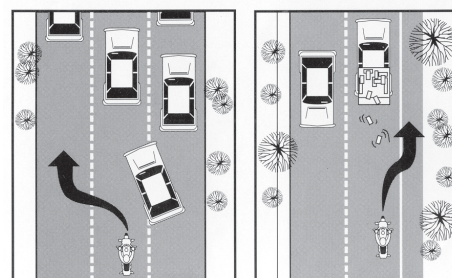

10.3 RIDING A CURVE: A primary cause of single-vehicle collisions is motorcyclists running wide in a curve or turn and colliding with the roadway or a fixed object.

Every curve is different. Be alert to whether a curve remains constant, gradually widens, gets tighter, or involves multiple turns.

Ride within your skill level and posted speed limits.

Your best path may not always follow the curve of the road. Change lane position depending on traffic and road conditions. If no traffic is present, and your riding abilities are up to it, you may choose to start at the outside of a curve to increase your line of sight and the effective radius of the turn. As you turn, move toward the inside of the curve, and as you pass the center, move to the outside to exit. For 3-wheel motorcycles, following the center of the lane may produce the greatest tipover forces.

Another alternative is to move to the center of your lane before entering a curve, and stay there until you exit. This permits you to spot approaching traffic as soon as possible. You can also adjust for traffic crowding the center line, or debris blocking part of your lane.

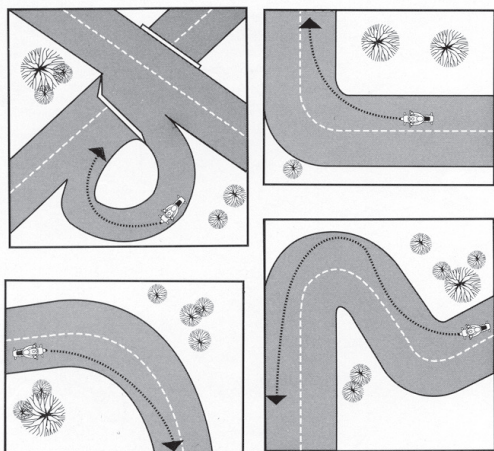

10.4 CORNERING: Cornering with a 3-wheel motorcycle has unique characteristics that must be considered. You must keep in mind that a 3-wheel motorcycle can tip over if it is turned too sharply when going too fast for the corner. It is essential that the operator slow before entering a corner to avoid this. When operating a sidecar-equipped motorcycle, additional consideration needs to be given to the direction of the turn and the amount of weight in the sidecar. Since the sidecar generally sits on the right side of the motorcycle, left turns are less difficult because the sidecar wheel bears the additional cornering forces or weight. A right-hand

turn, however, may cause the sidecar wheel to lift off the ground or “fly” if the corner is taken at too great a speed or taken when braking. This is best avoided by slowing before entering the turn, but can be controlled if the operator understands how to steer a 2-wheel motorcycle. The change from 3-wheel steering to 2-wheel steering is called steering reversion. This happens if the sidecar is high off the ground and the entire rig is at the balance point. Turning the handlebars in the direction you want to go turns 3-wheeled motorcycles, but 2-wheel turning is accomplished by counter steering. To bring a sidecar that is “flying,” or has its wheel in the air, to the ground, the operator needs to counter-steer to the right or steer to the left.

Other unique characteristics of 3-wheel motorcycles in corners are drifting and sliding. Both of these characteristics are related to tires not holding traction or slipping on the pavement. Sliding is the front tire slipping, resulting in a loss of steering. Drifting is the slipping of the rear wheel of the motorcycle and/or sidecar wheel. Drifting is unique to sidecar-equipped motorcycles. To initiate drifting, the operator shifts weight, rolls on the throttle while applying some front brake while turning (off camber turn). Done carefully, this technique may help to sharpen turns, particularly in left turns. Caution must be used while attempting to drift in a right turn since too much throttle and/or braking may cause the sidecar to fly.

11. MECHANICAL PROBLEMS

You can find yourself in an emergency the moment something goes wrong with your motorcycle. In dealing with any mechanical problem, take into account the road and traffic conditions you face. Here are some guidelines that can help you handle some mechanical problems safely.

11.1 TIRE FAILURE: If the cycle starts handling differently, pull off to check the tires. You will seldom hear a tire go flat. You must be able to tell when a tire has lost air suddenly from the way the cycle reacts.

If the front tire goes flat, the steering will feel “heavy.” If the rear tire goes flat, the back of the motorcycle will tend to jerk from side to side.

If either tire goes flat while riding:

- Hold the handle grips firmly and keep a straight course.
- If you know which tire is flat, gradually apply the other brake.
- When the motorcycle slows, edge to the side of the road and stop.

11.2 STUCK THROTTLE: Twist the throttle back and forth, this may free it. If the throttle stays stuck, immediately operate the engine cut-off switch and pull in the clutch. This will remove power from the rear wheel though engine noise may not immediately decline. Once you have the motorcycle “under control,” pull to the side of the road and stop.

After you have stopped, check the throttle cable carefully to find the source of the trouble. Make certain the throttle works freely before you start to ride again.

11.3 WOBBLE: A wobble occurs when the front wheel and handlebars suddenly start to shake from side-to-side at any speed.

Most wobbles can be traced to improper loading, the use of unsuitable accessories, or the use of incorrect tires or tire pressure. If you are carrying a heavy load, lighten it. If you can't lighten the load, shift it. Center the weight lower to the ground and farther forward on the cycle. Make sure tire pressure, spring pre-load, air shocks, and dampers are at the levels recommended by the manufacturer for carrying that much weight. If you have a windshield or fairing, make sure it is mounted properly.

In addition to the above items, other things that may contribute to wobble are poorly adjusted steering, worn steering parts, a front wheel that is bent, misaligned, or out of balance, loose wheel bearings, loose spokes and swing arm bearings.

DO NOT try to “accelerate” out of the wobble. That will only make the cycle more unstable. Instead:

- Grip the handlebars firmly, but don't try to fight the wobble.
- Close the throttle gradually, and let the motorcycle slow down. Do not apply the brakes; braking could make the wobble worse.
- Move your weight as far forward and down as possible.
- Pull off the road as soon as you can to fix the problem.

11.4 CHAIN PROBLEMS: If your chain slips or breaks while you're riding, it could lock the rear wheel and cause your cycle to skid.

SLIPPAGE: If the chain slips when you try to speed up quickly while riding uphill, pull off the road, and check the chain sprockets. Tightening the chain may help. If the problem is a worn or stretched chain or worn or bent sprockets, replace the chain, the sprockets, or both before riding again.

BREAKAGE: You'll notice an instant loss of power to the wheel. Close the throttle and brake to a stop.

11.5 ENGINE SEIZURE: Engine seizure means that the engine locks or freezes. Engines seize when they are low on oil. Without oil, the engine's moving parts can't move smoothly against each other, and the engine overheats. The first sign may be a loss of engine power or a change in the engine's sound.

Squeeze the clutch lever to disengage the engine from the rear wheel. Pull off the road and stop. Let the engine cool. You may be able to add oil and restart the engine.

12. SPECIAL SITUATIONS

12.1 FLYING OBJECTS: From time to time riders are struck by insects, cigarettes thrown from cars, or rocks kicked up by the tires of the vehicle ahead. If you aren't wearing face protection, you could be hit in the eye, face, or mouth. If you are wearing face protection, it might get smeared or cracked, making it difficult for you to see. Whatever happens, keep your eyes on the road and your hands on the handlebars. As soon as it is safe, pull off the road and repair the damage.

12.2 ANIMALS: Naturally, you should do everything you can to avoid hitting an animal. However, if you are in traffic, don't swerve out of your lane to avoid a small animal. Hitting something small is less dangerous to you than hitting something big, like a car.

Motorcycles seem to attract dogs. If you are chased, don't kick at the animal, shift down and approach the animal slowly. As you reach it, speed up quickly. You will leave the animal behind.

12.3 GETTING OFF THE ROAD If you need to leave the road to check the motorcycle (or just to rest for awhile), be sure you:

- Check the roadside. Make sure the surface of the roadside is firm enough to ride on. If it is soft grass, loose sand, or if you're just not sure about it, slow way down before you turn onto it.
- Signal others. Drivers behind might not expect you to slow down. As soon as you can, give a clear signal that you will be slowing down and changing direction. Make sure to check your mirror and make a head check before you take any action.
- Pull well off the road - Get as far off the road as you can. It can be very difficult to spot a motorcycle by the side of the road. You don't want someone else pulling off at the same place you are.

12.4 HILLS: When riding uphill on a 3-wheel motorcycle, some weight will shift to the rear, causing the front to be lighter. This weight shift means there is less traction on the front tire for steering and braking. Riding downhill means that gravity increases the amount of braking force required to stop or slow a 3-wheel motorcycle. It is important to slow even earlier for cornering or stopping.

13. CARRYING PASSENGERS AND CARGO

Only experienced riders should carry passengers or large loads. The extra weight changes the way the motorcycle handles, balances, turns, speeds up and slows down. Before taking a passenger or heavy load on the street, practice in a safe, off-road area.

13.1 PASSENGERS: To carry passengers safely you must make sure your motorcycle is equipped and adjusted to carry passengers.

- A proper seat. The seat should be large enough to hold both you and your passenger without crowding. You should not sit any further forward than you usually do.
- Foot pegs. The passenger must have his own set of foot pegs. Without a firm footing, your passenger can fall off and pull you off too.
- Protective gear. Passengers should have the same type of protective gear and clothing recommended for operators.

You should adjust the shocks to handle the extra weight. While your passenger sits on the seat with you, adjust the mirror and headlight to the change in the motorcycle's angle. It is a good idea to add a few pounds of pressure to the tires if you carry a passenger. Then adjust the suspension to handle the additional weight. (Check your owner's manual.)

INSTRUCT PASSENGERS: Even if your passenger is a motorcycle rider, provide complete instructions before you start. Instruct your passenger to:

- Get on the motorcycle after you have started the engine.
- Sit as far forward as possible without crowding you.
- Hold firmly to your waist, hips, or belt.
- Keep both feet on the pegs, even when the motorcycle is stopped.
- Keep legs away from the muffler.
- Stay directly behind you, leaning as you lean.

- Avoid unnecessary talk or motion.
- For 3-wheel motorcycles, keep hands inside the sidecar.

RIDING WITH PASSENGERS: Tell your passenger to tighten his/her hold when you approach surface problems, or are about to start from a stop. Your motorcycle will respond more slowly with a passenger on board. The heavier your passenger, the longer it will take to slow down, speed up or make a turn, especially on a light cycle.

- Ride a little slower, especially when taking curves, corners, or bumps.
- Start slowing earlier as you approach a stop.
- Open up a larger cushion of space ahead and to the sides.
- Wait for larger gaps when you want to cross, enter or merge with traffic.
- Warn your passenger of special conditions ahead such as when you will pull out, stop quickly, turn sharply or ride over a bump. Turn your head slightly to make yourself understood, but keep your eyes on the road ahead.

13.2 CARRYING LOADS: Most motorcycles are not designed to carry much cargo, however, small loads can be carried safely if they are positioned and fastened properly.

KEEP THE LOAD LOW: Fasten loads to the seat, or put them in saddle bags. Placing a load high against a bar or frame raises the cycle's center of gravity and disturbs its balance.

KEEP THE LOAD FORWARD: Place the load over or in front of the rear axle. Tank bags keep loads forward, but use caution when loading hard or sharp objects. Mounting loads behind the rear axle can affect how the motorcycle turns and brakes. It can also cause a wobble.

DISTRIBUTE THE LOAD EVENLY: Load saddle bags with about the same weight. An uneven load can cause the motorcycle to drift to one side.

SECURE THE LOAD: Fasten the load securely with elastic cords (bungee cords). A loose load can catch in the wheel or chain and the rear wheel may lock up and skid. Do not use rope as it tends to stretch and knots come loose, permitting the load to shift or fall off.

CHECK THE LOAD: Stop and check the load often to make sure it has not worked loose or moved.

14. GROUP RIDING

If you ride with others, you must do it in a way that promotes safety and doesn't interfere with the flow of traffic.

14.1 KEEP THE GROUP SMALL: A large group tends to interfere with traffic. It makes it necessary for cars to pass a long line of motorcycles at a time. Also, large groups tend to get separated easily by traffic or red lights. Those who are left behind often ride unsafely trying to catch up. If your group is larger than four or five riders, divide it into two or more smaller groups.

14.2 KEEP THE GROUP TOGETHER:

PLAN AHEAD: The leader should look ahead for changes. Give signals early so "the word" gets back in plenty of time. Start lane changes early enough to allow everyone to complete the change.

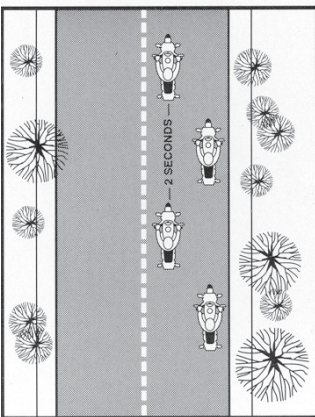

PUT BEGINNERS UP FRONT: Place inexperienced riders behind the leader, where they can be watched by more experienced riders.

FOLLOW THOSE BEHIND: Let the tailrider set the pace. Use your mirrors to keep an eye on the person behind. If a rider falls behind slow down a little, so the group will stay with the tailrider.

KNOW THE ROUTE: Make sure everybody knows the route. Then, if someone is separated for a moment, he or she won't have to hurry to avoid getting lost or taking a wrong turn.

14.3 KEEP YOUR DISTANCE : Maintain close ranks at a safe distance. A close group takes up less space on the highway, is easier to see, and is less likely to be separated. However, it must be done properly.

DON'T PAIR UP: Never operate directly alongside another motorcycle rider. If one of you has to avoid a car or something on the road, there would be no place to go. To talk, wait until you are both stopped.

STAGGERED FORMATION: Riding in a staggered formation is the best way to keep ranks close and yet maintain an adequate space cushion. The leader rides to the left side of the lane, while the second rider stays a little behind and rides to the right side of the lane. A third rider would take the left position, a normal two-second distance behind the first rider. The

fourth rider would be a normal two-second distance behind the second rider. This formation keeps the group close and keeps each rider a safe distance from the others ahead, behind, and to the sides.

A staggered formation can be used safely on an open highway. However, it is best to move into a single file formation when taking curves, making turns, or entering or leaving a highway.

PASSING INFORMATION: Riders in a staggered formation should pass one at a time. First, the lead rider should pull out and pass when it is safe. After passing, the leader should return to the left position and continue riding at a passing speed until he has opened up room for the next rider. When the first rider has passed safely, the second rider should move up the left position and watch for a safe chance to pass. After passing, this rider should return to the right position and open up room for the next rider.

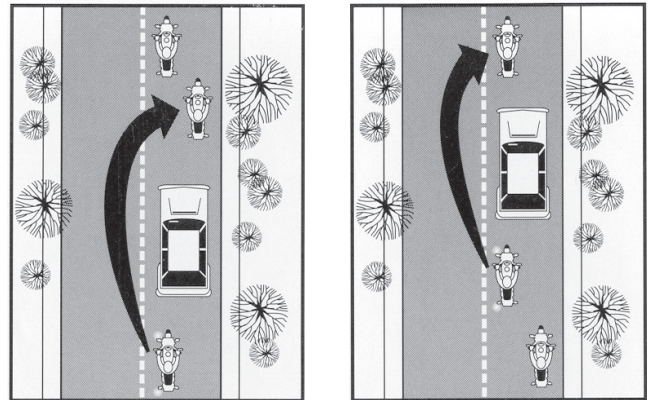

NOTE: Some people suggest that the leader should move to the right side after passing a vehicle. This is not a good idea. It encourages the second rider to pass and cut back in before a large enough cushion of space has been opened up in front of the passed vehicle. It's simpler and safer if each rider waits until there is enough room ahead of the passed vehicle to allow the rider to move into the same position held before the pass.

15. YOUR MOTORCYCLE

There are plenty of things on the highway that can cause you trouble. Your motorcycle should not be one of them. To make sure your motorcycle won't let you down, start with the right equipment, keep it in a safe riding condition and avoid add-ons or modifications that make your cycle harder to handle.

15.1 THE RIGHT EQUIPMENT: First, make sure your motorcycle is right for you. It should "fit" you. Your feet should be able to reach the ground while you are seated on the cycle.

Accidents are fairly common among beginning riders, especially in their first six months of riding. Don't try a "big bike" until you have a lot of riding experience. No matter how experienced you may be, ride extra carefully on any bike that's new or unfamiliar to you. More than half of all accidents occur on cycles their riders have used for less than six months.

15.2 MOTORCYCLE CARE: A motorcycle needs more frequent attention than a car. A minor mechanical failure in a car seldom leads to anything more than an inconvenience for the driver. When something goes wrong with a motorcycle, it may cause an accident.

The only way to head off problems before they cause trouble is to inspect your motorcycle carefully and often. If you find something wrong, fix it right away. Refer to your owner's manual for proper care and maintenance.

16. MOTORCYCLE OPERATOR SKILLS TEST

The Motorcycle Safety Foundation (MSF) is a state approved Skill Test for both two and three wheel vehicles. The test consists of exercises that evaluate your ability to perform basic vehicle control, riding judgment, and hazard response skills.

Prior to being tested, you must show valid proof of insurance and valid registration for the motorcycle you will be using on the test. A safety check of your motorcycle will include; headlights, taillights, brake lights, turn signals, mirrors, and tire tread depth. The engine size of the motorcycle must be rated at over 50cc

The test consists of six riding exercises that measure your vehicle control and hazard response skills. You will be scored on time and distance standards as well as path violations and foot down violations. The test may be ended for point accumulation, committing an unsafe act, stalling the vehicle four times, or failure to understand or follow instructions. You may stop the test at any time, but you must complete the entire test to pass it.

You will be tested on the following exercises:

2-Wheel Motorcycle

- Cone Weave: There are five cones spaced 12 feet apart in a straight line. Do not skip or touch any cones or put your foot down.
- Normal Stop: Make a smooth, non-skidding stop.
- Turn from a Stop: Make a right turn between the boundary lines. Do not touch either line or put a foot down.

- Left U-Turn: Do not put your foot down or touch the solid line or dashed line (depending on the size of your motorcycle).
- Quick Stop: From approximately 12 to 18 MPH, stop the motorcycle safely but as quickly as you can. You are not marked down if you skid, but will lose points if you lose control.
- Obstacle Swerve: From approximately 12 to 18 MPH, swerve the motorcycle safely to the right or left of the obstacle line, staying inside the indicated boundaries. Do not touch the obstacle line or the boundaries.

3-Wheel Motorcycle

- Left Turn: Mark a sharp left turn between the outside boundary line and the cone marker. Do not touch the outside line or the cone.
- Normal Stop: Make a smooth, non-skidding stop with your front tire inside the box (left front tire on vehicles with two front tires).
- Cone Weave: There are three cones spaced at 18 feet apart in a straight line. Do not skip or touch any cones.
- Turn From A Stop: Make a right hand turn between the outside boundary line and the cone. Do not touch the outside boundary lines or the cone.
- Quick Stop: From approximately 12 to 18 MPH, stop the motorcycle safely but as quickly as you can. You are not marked down if you skid, but will lose points if you lose control.
- Obstacle Swerve: From approximately 12 to 18 MPH, swerve the motorcycle safely to the right or left of the obstacle line, staying inside the indicated boundaries. Do not touch the obstacle line or the boundaries.

2-WHEEL MOTORCYCLE TEST COURSE

1 - Cone Weave, Normal Stop

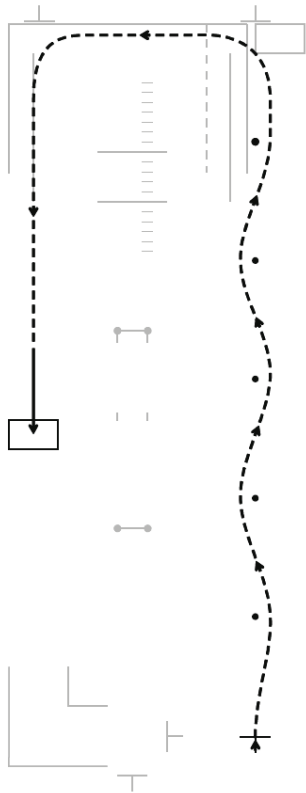

2 - Turning from a Stop, U-turn

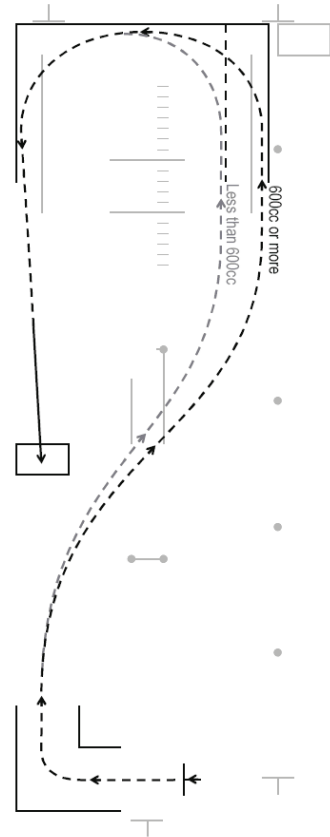

3 - Quick Stop

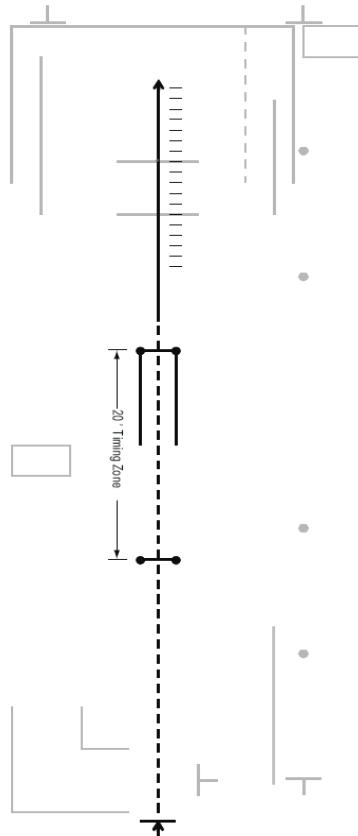

4 - Obstacle Swerve

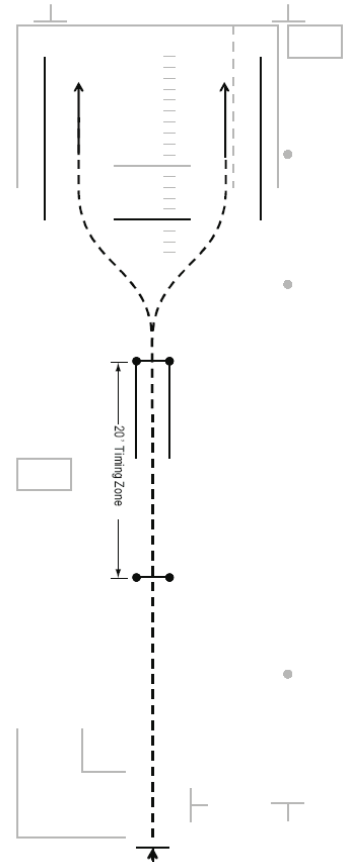

3-Wheel Motorcycle Test Course

1 - Left Turn, Normal Stop

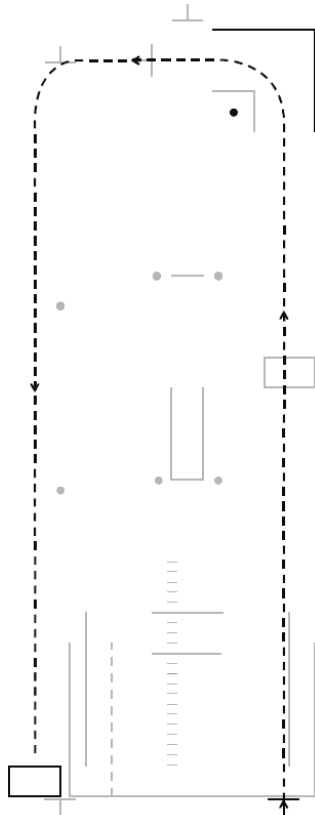

2 - Cone Weave, Turn from a Stop

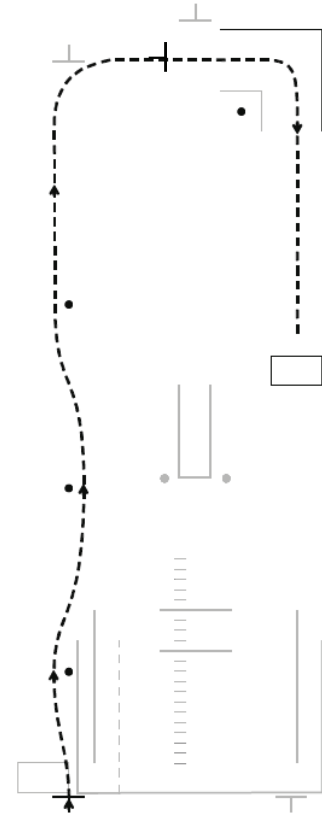

3 - Quick Stop

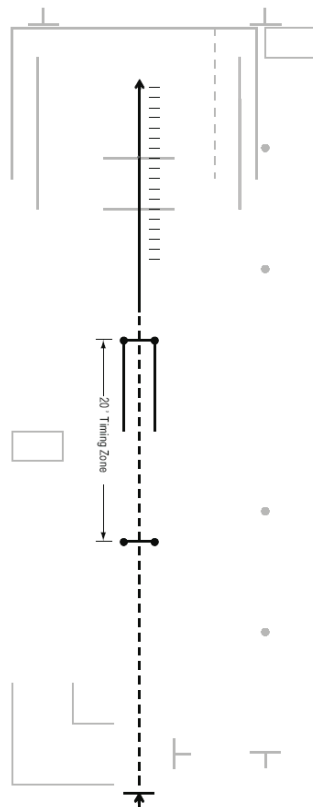

4 - Obstacle Swerve

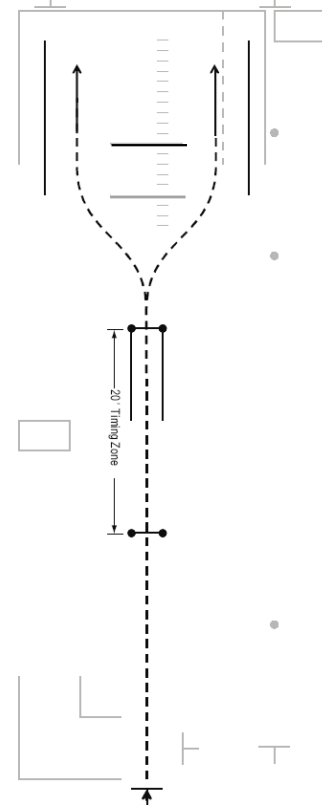

Notes



MOST

Motorcycle Operator Safety Training

*Make the **most** of your ride*

*Experience the joys and thrills of motorcycle riding in Colorado.
If you are a new rider begin with the Basic Rider Course:*

*Motorcycles, helmets, and study material provided.
Successful completion waives the skills test for your
motorcycle endorsement.*

The Experienced Rider Course:

*For the experienced rider there is always more to
learn to increase your riding enjoyment and safety.*



Ride **WISE**

Find a MOST training class at **COMOST.COM**

