

MOTORCYCLE OPERATOR MANUAL

*Supplement to the Digest of
Ohio Motor Vehicle Laws*

Ohio

**Bureau of
Motor Vehicles**

Motorcycle **Ohio**

For course information go to:
www.motorcycle.ohio.gov



PREFACE

Because operating a motorcycle is different than operating a motor vehicle, the Motorcycle Operator Manual was produced.

The manual is an important tool for the inexperienced rider to gain the information necessary to operate a motorcycle safely in traffic. Even the experienced rider can find something new in this manual.

Education and public awareness are the keys to reducing the number of motorcyclists killed and injured on our highways. The Motorcycle Ohio (MO) program, offered by the Ohio Department of Public Safety, provides motorcycle safety courses for riders, as well as public information campaigns. Information on the course is included in this manual or you can email the Motorcycle Ohio office at Mogen@dps.ohio.gov. Research comparing MO graduates and untrained motorcyclists has found that course graduates involved in crashes are more likely to be helmeted, insured and unimpaired.

The motorcycle crash problem is complex. A variety of countermeasures have been implemented over the past several years to effectively reduce the number of fatalities and injuries associated with motorcycle crashes in Ohio. The Ohio Department of Public Safety is making every effort possible to provide the programs and education to reduce the tragedies suffered on our roadways by motorcyclists.

Reading this manual and gaining the knowledge required to operate a motorcycle safely will add to the enjoyment you experience as a motorcycle rider.

To schedule a road test, visit www.ohiodrivingtest.com.

Ohio

**Department of
Public Safety**

Ohio

**Bureau of
Motor Vehicles**

*Motorcycle*Ohio

CONTENTS

How to Obtain a Temporary Motorcycle or Scooter Learner’s Permit	i
Motorcycle Ohio Reciprocity Policy (Out-of State Safety Classes)	i
How To Obtain a Motorcycle or Scooter License or Endorsement	ii
Earning Your License	iii
Knowledge Test	iii
On-Cycle Skill Test	iv
Did You Know	iv
Rider Skill Test-2 Wheel and/or Scooter	v
Rider Skill Test-3 Wheel.....	vi
Ohio Driver License Exam Stations.....	vii - ix
Motorcycle Ohio (MO) Program	x - xi
Interested in Becoming a MO Instructor	xii
MO’s Instructor Preparation	xiii

THE RIDER AND THE MOTORCYCLE

The Rider and The Motorcycle	1
Riding Environment	1

PREPARING TO RIDE

Wear The Right Gear	2
Helmet Use	2
Helmet Selection	2
Eye and Face Protection	3
Clothing.....	3
Know Your Motorcycle	4
The Right Motorcycle for You	4
Borrowing and Lending	5
Get Familiar with the Motorcycle Controls	5
Check Your Motorcycle	6
Know Your Responsibilities	7

RIDE WITHIN YOUR ABILITIES

Basic Vehicle Control.....	8
Body Position	8
Shifting Gears.....	8
Braking.....	9
Breaking in a Corner.....	10
Linked and Integrated Braking Systems	10
Anti-Lock braking Systems (ABS)	10
Turning	11
Keeping Your Distance	12
Lane Positions	12
Following Another Vehicle	13
Being Followed	14
Passing and Being Passed	14

Lane Sharing	15
Merging Cars.....	16
Cars Alongside.....	16
See (search, evaluate, execute)	17
Intersections	18
Blind Intersections.....	20
Passing Parked Cars	20
Parking at the Roadside	21
Increasing Conspicuity	21
Clothing	21
Headlights.....	21
Signals	22
Brake Light	22
Using Your Mirrors	22
Head Checks.....	23
Horn	23
Riding at Night.....	24
Crash Avoidance	24
Quick Stops	24
Stopping Quickly in a Curve.....	25
Swerving or Turning Quickly	25
Maximum Straight-Line Braking	26
Front-Wheel Skids.....	26
Rear-Wheel Skids	27
Curves	27
Handling Dangerous Surfaces	27
Uneven Surfaces and Obstacles	27
Slippery Surfaces	28
Railroad Tracks, Trolley Tracks and Pavement Seams	30
Grooves and Gratings	30
Mechanical Problems	30
Tire Failure	30
Stuck Throttle.....	30
Wobble	30
Drive Train Problems	31
Engine Seizure.....	31
Animals.....	31
Flying Objects.....	32
Getting Off The Road.....	32
Carrying Passengers And Cargo	32
Preparing Your Motorcycle	32
Equipment for Carrying Passenger	32
Preparing Your Passengers to Ride	33
Riding With Passengers.....	33
Carrying Loads	34

BEING IN SHAPE TO RIDE

Tips for Traveling With Passengers and Cargo	35
Pre-Ride Test.....	36
Group Riding	36
Preparation.....	36
Plan.....	36
Hand Signals.....	36
Follow Those Behind.....	36
Keep Your Distance.....	37
Don't Pair Up.....	37
Staggered Formation.....	37
Intersections.....	37
Interstate Highways and Freeways.....	37
Parking.....	37
Passing In Formation.....	38
Ten Rules of Group Riding.....	39
Why This Information Is Important	40
Alcohol And Drugs In Motorcycle Operation	40
Alcohol In The Body.....	40
Blood Alcohol Concentration.....	41
Alcohol And The Law.....	42
Alcohol And Ohio's Law.....	42
Consequences of Conviction.....	42
Minimize The Risks.....	43
Step In To Protect Friends.....	43
Marijuana and Motorcycle Operation.....	44
Fatigue.....	44

THREE-WHEEL SUPPLEMENT

Supplementary Information for Three-Wheel Motorcycles	46
Know Your Vehicle	46
Three-Wheel Motorcycle Designs.....	47
The Right Motorcycle for You.....	47
Borrowing and Lending.....	47
Get Familiar with Motorcycle Controls.....	47
Basic Vehicle Control	48
Steering & Tip.....	48
Body Position.....	48
Braking.....	48
Turning.....	48
Hills.....	49
Lane Position.....	50
Parking at the Roadside.....	50
Acceleration and Deceleration.....	50
Swerving.....	50
Cornering & Curves.....	50
Carrying Passengers and Cargo	51
Answers to Questions	52
Hand Signals	53, 54
T-CLOCS: Pre:Ride Inspection Checklist.....	55

HOW TO OBTAIN A TEMPORARY MOTORCYCLE OR SCOOTER LEARNER'S PERMIT

Step 1: To help you study for the knowledge test, be sure to pick up a Motorcycle Operator Manual and a Digest of Ohio Motor Vehicle Laws.

Step 2: Proceed to any exam station to complete the knowledge test. Upon successfully passing the knowledge test proceed to any Deputy Registrar to obtain the Temporary Instruction Permit Identification card (T.I.P.I.C.).

Motorcycle knowledge test may be taken at certain Deputy Registrars. Visit www.bmv.ohio.gov for locations.

TEMPORARY PERMIT

HOLDER SPECIAL RESTRICTIONS

- Daylight hours only
- No passengers
- Not valid on congested roads and interstate highways
- Must wear approved protective helmet and use eye protection

Note: All first-year endorsed operators and any passengers must wear a helmet.

The permit is valid one year from issue date and allows you to ride with some restrictions.

MOTORCYCLE OHIO RECOPROCITY POLICY

Adding a Motorcycle Endorsement to a Driver License for regular license holders who have successfully completed an out-of-state motorcycle safety course.

Contact Motorcycle Ohio at 1-800-837-4337 or via their email mogen@dps.ohio.gov for details.

HOW TO OBTAIN A MOTORCYCLE OR SCOOTER LICENSE OR ENDORSEMENT

Anyone wishing to obtain a motorcycle license or endorsement must either complete motorcycle skills testing at an Driver Exam Station or complete the Motorcycle Ohio Basic Course.

Applicants under 18 years of age are required to complete the Motorcycle Ohio Basic Course and complete Graduated Driver Licensing requirements to be eligible to purchase the motorcycle or scooter license or endorsement only. Applicants 18 years of age or older are not required to complete the motorcycle course.

The Motorcycle Ohio Basic Course completion card is valid to waive motorcycle skills testing for a period of 60 days from the date of issuance. After 60 days, all applicants for a motorcycle license or endorsement must complete motorcycle skills testing at the driver license exam station.

TESTING TO OBTAIN YOUR MOTORCYCLE OR SCOOTER LICENSE/ENDORSEMENT

Step 1: Contact a driver license exam station to make an appointment for the on-cycle examination. No fee is charged for this test.

Step 2: You must bring your T.I.P.I.C. and a street-legal motorcycle or scooter to the exam site. A helmet and eye protection must be worn during the test.

Step 3: After you have passed the on-cycle test, the examiner may provide you with a receipt to take to any Deputy Registrar agency.

Step 4: Present the T.I.P.I.C. along with a receipt (for motorcycle-only license holders) or driver license (for motorcycle endorsement holders) to the Deputy Registrar to receive the license or endorsement. A fee will be charged for the new license.

COMPLETE THE MOTORCYCLE OHIO BASIC SKILLS COURSE

Step 1: After successfully completing the Motorcycle Ohio Basic Skills, Motorcycle Ohio (MO) Basic Rider Skills - Returning Rider (RR), or Basic Rider Skills-2, you will be issued a course completion card by the course instructor.

Step 2: Within 60 days of card issuance, present the motorcycle temporary permit (T.I.P.I.C.) to the Deputy Registrar to receive the license or endorsement. A fee will be charged for the license.

YOU MUST HAVE A VALID MOTORCYCLE PERMIT OR ENDORSEMENT TO PARTICIPATE IN A MOTORCYCLE RIDER COURSE.

Note: Only minor students may use a scooter in a motorcycle training course. Motorcycle Ohio will not provide scooters for the riding portion of our courses. For additional information on scooters, please visit www.motorcycle.ohio.gov.

EARNING YOUR LICENSE

Safe riding requires knowledge and skill. Licensing tests are the best measurement of the skills necessary to operate safely in traffic. Assessing your own skills is not enough. People often overestimate their own abilities. It's even harder for friends and relatives to be totally honest about your skills. Licensing exams are designed to be scored more objectively.

To earn your license, you must pass a knowledge test and an on-cycle skill test. Knowledge test questions are based on information, practices and information from this manual. They require that you know and understand road rules and safe riding practices. An on-cycle skill test will either be conducted in an actual traffic environment or in a controlled, off-street area.

KNOWLEDGE TEST

(Sample Questions)

1. It is MOST important to flash your brake light when:

- a. Someone is following too closely.
- b. You will be slowing suddenly.
- c. There is a stop sign ahead.
- d. Your signals are not working.

2. The FRONT brake supplies how much of the potential stopping power?

- a. About 25%.
- b. About 50%.
- c. About 70%.
- d. All of the stopping power.

3. To swerve correctly:

- a. Shift your weight quickly.
- b. Turn the handlebars quickly.
- c. Press the handlegrip in the direction of the turn.
- d. Press the handlegrip in the opposite direction of the turn.

4. If a tire goes flat while riding and you must stop, it is usually best to:

- a. Relax on the handlegrips.
- b. Shift your weight toward the good tire.
- c. Brake on the good tire and steer to the side of the road.
- d. Use both brakes and stop quickly.

5. The car below is waiting to enter the intersection. It is best to:

- a. Make eye contact with the driver.
- b. Reduce speed and be ready to react.
- c. Maintain speed and position.
- d. Maintain speed and move right.

Answers to Knowledge Test
(see next page)

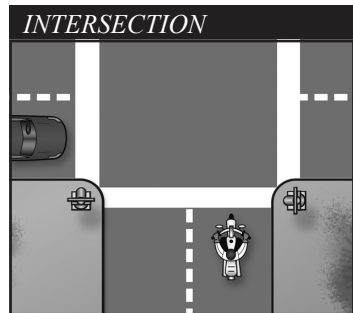

ON-CYCLE SKILL TEST

Basic vehicle control and crash-avoidance skills are included in on-motorcycle tests to determine your ability to handle normal and hazardous traffic situations.

You may be tested for your ability to:

- Know your motorcycle and your riding limits.
- Accelerate, brake and turn safely.
- See, be seen and communicate with others.
- Adjust speed and position to the traffic situation.
- Stop, turn and swerve quickly.
- Make critical decisions and carry them out.

Examiners may score on factors related to safety such as:

- Selecting safe speeds to perform maneuvers.
- Choosing the correct path and staying within boundaries.
- Completing normal and quick stops.
- Completing normal and quick turns or swerves.

DID YOU KNOW...

On July 6, 2000, Governor Taft signed Senate Bill 271 into law, which states that students who successfully complete the Motorcycle Ohio (MO) Basic Skills or Basic Rider Skills-RR will have the state of Ohio Motorcycle Skill test waived.

MO graduates will receive the motorcycle endorsement/license upon presenting their course completion card to a Deputy Registrar. Graduates

less than 18 years of age must also meet additional requirements. The Skill Test Waiver became effective January 1, 2001.

For more information on Motorcycle Ohio, visit our Web site at www.motorcycle.ohio.gov

To receive a motorcycle license with full privileges, Ohio requires that motorcycle maneuvers be performed as designed. The on-cycle skills test is not designed for sidecars or three-wheel vehicles but can be altered to accommodate those. If an on-cycle skills test is performed using a sidecar or three-wheel vehicle, the endorsement received will not permit operation of a two-wheel motorcycle.

Diagrams and drawings used in this manual are for reference only and are not to correct scale for size of vehicles and distances.

Answers to Knowledge Test

1-B 2-C 3-C 4-C 5-B

Rider Skill Test - 2 Wheel and/or Scooter

1 - Cone Weave, Normal Stop

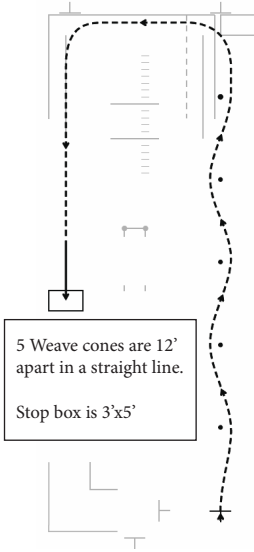

2 - Turning from a Stop, U-turn

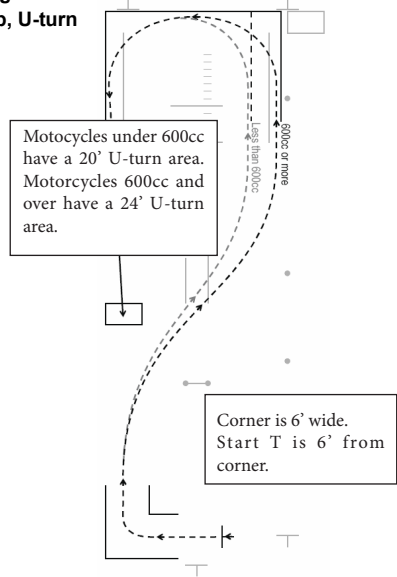

3 - Quick Stop

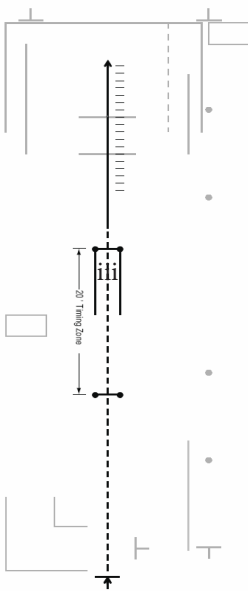

4 - Obstacle Swerve

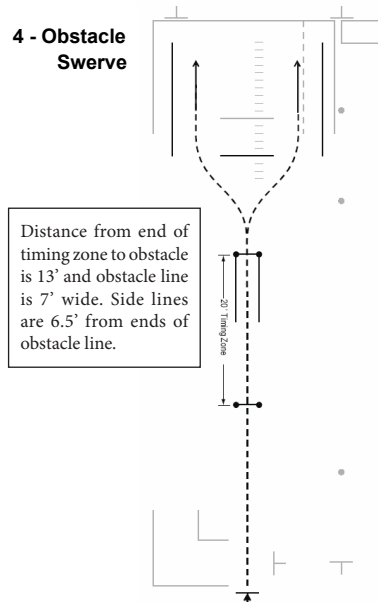

Rider Skill Test - 3 Wheel

1 - Left Turn, Normal Stop

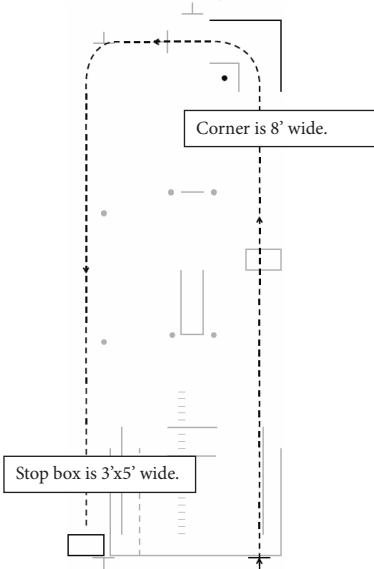

2 - Cone Weave, Turn from a Stop

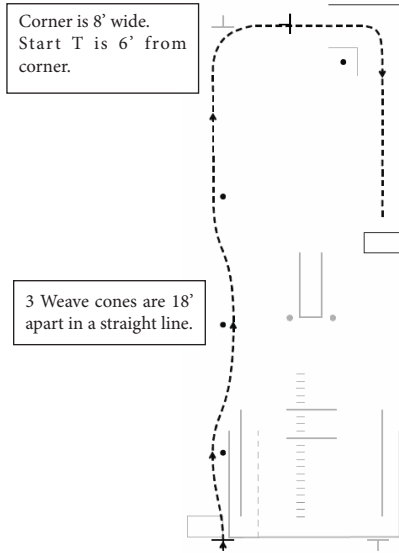

3 - Quick Stop

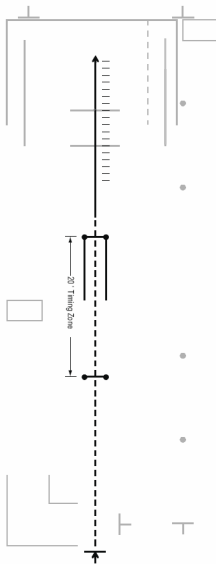

4 - Obstacle Swerve

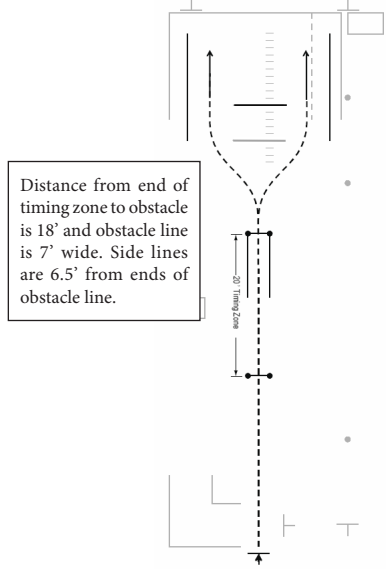

Ohio Driver License Examination Stations
To schedule a skills test, visit www.ohiodrivingtest.com or
call 877-4DX-TEST (877-439-8378)

County	Address	Days Open
Allen	419 Elizabeth St., Suite C Lima	Tues-Sat
Ashtabula	77 N. Chestnut Street Jefferson	Tues-Sat
Athens	1002 East State Street, Suite 20 Athens	Tues-Sat
Belmont	320 Hall Street Bridgeport	Tues-Sat
Butler	1720-B South Erie-Highway, Bldg C Hamilton	Tues-Sat
Clark	Park Shopping Center 1139 Bechtle Ave., Springfield	Tues-Sat
Clermont	457 West Main Street Batavia	Tues-Sat
Clinton	State Highway Patrol 950 Rombach Ave., Wilmington	Thurs-Sat
Columbiana	7735-C State Route 45 Lisbon	Tues-Sat
Coshocton	706 S. 7th Street Coshocton	Tues-Wed
Crawford	1653 Marion Road Bucyrus	Tues-Sat
Cuyahoga	22133 Rockside Road Bedford	Tues-Sat
Cuyahoga	6420 Mayfield Road Mayfield Heights	Tues-Sat
Cuyahoga	12000 Snow Road Parma	Tues-Sat
Darke	641 Wagner Avenue Greenville	Tues, Sat,
Defiance	999 Procom Street, Suite 104 Defiance	Tues-Sat
Delaware	2079 US 23 Delaware	Tues-Sat
Fairfield	980 Liberty Drive, Suite 200 Lancaster	Tues-Sat
Franklin	1583 Alum Creek Columbus	Tues-Sat
Franklin	990 Morse Road Columbus	Tues-Sat
Franklin	4738 Cemetery Road Hilliard	Tues-Sat
Fulton	152 S. Fulton Street Wauseon	Thurs-Fri

Ohio Driver License Examination Stations

County	Address	Days Open
Greene	601 Ledbetter Road, Ste. C Xenia	Tues-Sat
Hamilton	11177 Reading Road, Ste. 201-202 Cincinnati (Sharonville)	Tues-Sat
Hamilton	10940 Hamilton Avenue Seven Hills	Tues-Sat
Hancock	8210 County Road 140 Findlay	Tues-Sat
Huron	142 Cleveland Road Norwalk	Tues-Sat
Jackson	502 McCarty Lane Jackson	Wed-Sat
Lake	2736 North Ridge Road, Unit 7 Painesville	Tues-Sat
Lawrence	2717 S. Third Street, Suite B Ironton	Tues-Sat
Licking	873 E. Main Street Newark	Tues-Sat
Logan	1365 N. County Road 32, Suite #1 Bellefontaine	Thurs-Sat
Lorain	657 Chestnut Commons Dr. Elyria	Tues-Sat
Lucas	4458 Heatherdowns Plaza Toledo	Tues-Sat
Mahoning	417 E. Main Street Canfield	Tues-Sat
Marion	222 W. Center Street Marion	Tues-Sat
Medina	970 N. Court Street Medina	Tues-Sat
Mercer	330 Portland Street, Suite 1 Celina	Thurs-Sat
Miami	1275 Experiment Farm Road Troy	Tues-Sat
Montgomery	6134 Chambersburg Road Huber Heights	Tues-Sat
Muskingum	2324 June Parkway Zanesville	Tues-Sat
Portage	444 S. Meridian Street Ravenna	Tues-Sat
Preble	530 Junction Village Eaton	Tues-Sat
Richland	2012 West 4th Street Ontario	Tues-Sat
Ross	475 Western Avenue, Suite L Shawnee Square, Chillicothe	Tues-Sat
Sandusky	500 W. State Street Fremont	Tues-Sat

Ohio Driver License Examination Stations

County	Address	Days Open
Scioto	3980 Rhodes Avenue New Boston	Tues-Sat
Stark	3195 Whitewood Street, N.W. North Canton	Tues-Sat
Summit	650 Graham Rd. Cuyahoga Falls	Tues-Sat
Summit	21 Fifth St., S.E. Barberton	Tues-Sat
Trumbull	5555 Youngstown Warren Rd #203 Niles	Tues-Sat
Tuscarawas	1260 Monroe Avenue New Philadelphia	Tues-Sat
Van Wert	10234 Van Wert-Decator Road Van Wert	Fri, Sat
Warren	19-B Dave Avenue Lebanon	Tues-Sat
Washington	148-A Gross Street Frontier Shopping Center, Marietta	Tues-Sat
Wayne	340 South Market Wooster	Tues-Sat
Wood	1616 E. Wooster Street Bowling Green	Tues-Sat

Note: Some addresses and scheduled days and times may change due to relocations.
For additional information, please visit www.bmv.ohio.gov

To schedule a road test visit www.ohiodrivingtest.com

MOTORCYCLE OHIO PROGRAM

ABOUT THE BASIC RIDING SKILLS (BRS)

- Motorcycles, helmets and workbooks are provided.
- Students must have a validated motorcycle temporary permit (T.I.P.I.C.) or motorcycle endorsement before the first riding session.
- Students must provide their own over-the-ankle sturdy footwear, gloves, long sleeve shirt or jacket, long pants and a Department of Transportation (DOT) approved helmet if they bring their own.
- Each motorcycle rider course is scheduled for 16 hours.
- As a minimum, each student must be able to ride a bicycle.
- All course times and dates are subject to change.

The Motorcycle Ohio program charges a nominal fee to all registrants.

ABOUT THE BASIC RIDING SKILLS – RETURNING RIDER (BRS-RR)

The BRS-RR provides training for individuals 18 and older that are returning to riding but don't have an endorsement and/or have been riding on a temporary permit longer than one year.

- Each course scheduled for 8 hours
- Must have a TIPIC or Endorsement
- Motorcycles and helmets provided
- See www.motorcycle.ohio.gov for more info

Students who successfully complete the Motorcycle Ohio Basic Skills or Returning Rider Skills will have the State of Ohio skill test waived and will receive their motorcycle endorsement/license upon presenting the (T.I.P.I.C.) to a Deputy Registrar within 60 days. Graduates under 18 years of age successfully completing the BRS only, must also meet Graduated Driver License requirements.

MOTORCYCLE OHIO PROGRAM

ABOUT THE BASIC RIDING SKILLS-2 (BRS2)

- 7-hour, one-day, range-only course (no formal classroom session)
- Students must bring their own motorcycle, proof of motorcycle insurance, over-the-ankle sturdy footwear, gloves, long shirt or jacket, long pants and a Department of Transportation–approved helmet.
- Each operator must have a valid Temporary Instruction Permit Identification Card (TIPIC) or motorcycle license or endorsement.
- Successful completion earns the BMV skill test waiver for a motorcycle endorsement.
- A \$50 fee per person is charged to cover some of the cost.
- Use your own 2-wheeled street legal motorcycle.
- Passengers permitted only for riders which a motorcycle license or endorsement
- All course times/dates are subject to change.

ADVANCED RIDING SKILLS (ARS)

- Students must bring their own motorcycle, proof of motorcycle insurance, over-the-ankle sturdy footwear, gloves, long shirt or jacket, long pants and a Department of Transportation–approved helmet.
- The ARS complements an experienced rider's basic skills and helps with personal risk assessment.
- Each operator must have a motorcycle license or endorsement.
- A \$50 fee per person is charged to cover some of the cost.
- Use your own 2-wheeled street legal motorcycle.
- 9-hour, one-day, range-only course (no formal classroom session)
- Each BRS2 is scheduled for six hours and the ARS nine hours.
- No co-riders are permitted in the ARS.
- All course times/dates are subject to change.

Visit our Web site for courses offered at: www.motorcycle.ohio.gov for a course location near you!

Interested in Becoming a MO Instructor?

The MO Program has a need for skilled and dedicated motorcyclists with good communication skills.

Instructor Candidate qualifications:

- (A) The department shall certify an individual to teach the BRS if the individual meets the following conditions:
- (1) Submits to the department a completed application on a form approved by the director; No applicant shall submit an application that contains false or misleading information;
 - (2) Possesses a high school diploma or GED;
 - (3) Is currently an experienced motorcycle operator, licensed for at least three years preceding the date of the application with a valid motorcycle endorsement and currently rides a motorcycle on a regular basis;
 - (4) Has a driving record free of any of the following:
 - (a) Three or more chargeable crashes within the three years preceding the date of application;
 - (b) Three or more moving violation convictions under Chapter 4511. of the Ohio Revised code, or equivalent convictions from another jurisdiction, within the three years preceding the date of application;
 - (c) An accumulation of six or more points under Chapter 4510. of the Revised Code, or equivalent action from another jurisdiction, within the three years preceding the date of application;
 - (d) A twelve-point administrative action under section 4510.037 of the Ohio Revised code, or equivalent convictions from another jurisdiction, within the ten years preceding the date of application.
 - (e) A suspension and/or conviction under section 4511.19 of the Revised Code, or equivalent conviction from another jurisdiction, within five years preceding the date of application.
 - (5) Upon request, submits a criminal abstract provided and dated by the bureau of criminal identification and investigation within forty-five days of such request.

For more information email: mogen@dps.ohio.gov.

MOTORCYCLE OHIO INSTRUCTOR PREPARATION

PRIOR TO THE COURSE

- All Instructor Candidates (IC) must have taken and successfully completed the Basic Riding Skills (BRS) within 24 months prior to the Instructor Preparation Course (IPC). No other course, such as the Advanced Riding Skills (ARS), will meet this requirement. This is to insure that the IC has a working knowledge of the course structure, is familiar with the curriculum and can perform all of the exercises.
- All IC's must complete a home study assignment prior to the start date of the IPC. This assignment will take the average candidate approximately six to eight hours to complete. The purpose of this home study assignment is to thoroughly familiarize the candidate with all written materials.
- All IC's must be registered for the IPC with a tuition fee, up to \$100, paid to Motorcycle Ohio no later than two weeks prior to the start date of the course.
- Motorcycle Ohio reserves the right to cancel an IPC due to low enrollment.
- All applicants must be pre-approved by the Motorcycle Ohio Coordinator to become enrolled in the IPC.

SCHEDULING

- Typically the IPC will take place on five Saturdays and/or Sundays from 8 a.m. to 6 p.m. Student teaching will be scheduled on a regular scheduled BRS weekend. The IC must be present for the entire BRS course.

CONTENTS

- The instructional portion of the IPC consists of approximately 90 plus hours of time, split between in-person, online, and hybrid study sessions that cover classroom and range instruction. The purpose of this portion of the IPC is to teach instructor candidates how to teach the Basic Rider Skills (BRS) to novice students.
- Besides the BRS curriculum, other topics will include background and organizational information, classroom teaching techniques, range coaching techniques and range management.

COMPLETION REQUIREMENTS

- Candidates must attend all scheduled sessions of the IPC and must attend the entire BRS course during student teaching.
- All IC's must pass a riding test, a closed book written test and successfully pass a student teaching evaluation in order to become certified instructors.
- At the discretion of the MO staff, an IPC qualifying session may be scheduled to administer the riding test, pass out course materials and answer IC questions.

THE RIDER AND THE MOTORCYCLE

Motorcycling is a unique experience. Compared to a car, you don't sit in a motorcycle, you become part of it. Not as a passive driver, but as an active rider arcing into a string of smooth corners, playing along with the rhythm of the road; shifting, accelerating, and braking with precision. Whether you ride to and from work or prefer the camaraderie of a group ride on the weekend, motorcycling engages all your senses and creates an invigorating sense of freedom.

Along with that freedom comes responsibility. All states require some form of license endorsement demonstrating you possess a minimum level of skill and knowledge. This booklet and other motorcycle publications can help prepare you to be successful. You might also consider taking a formal hands-on training course, even if your state doesn't require that you complete one. You'll learn how to improve your riding skills and mental strategies, so you can be a safer, more alert rider.

The diagram above illustrates the complex environment that awaits you, and supports the concept that, as the Motorcycle Safety Foundation says, "Safe riding depends as much on the mental skills of awareness and judgment as it does on a physical skill of maneuvering the machine."

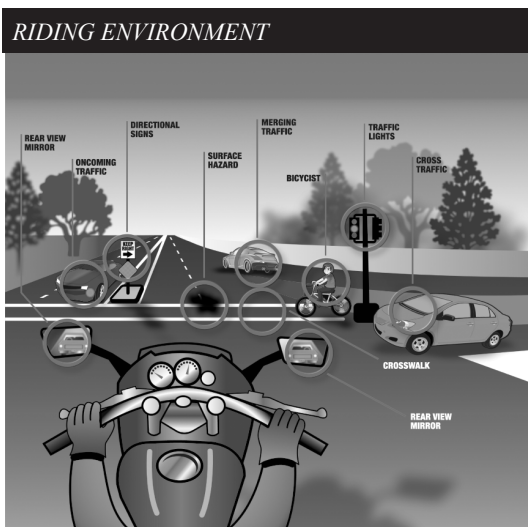

Successfully piloting a motorcycle is a much more involved task than driving a car. Motorcycling requires a fine sense of balance and a heightened sense of awareness and position amidst other roadway users. A motorcycle responds more quickly to rider inputs than a car, but is also more sensitive to outside forces, like irregular road surfaces or crosswinds. A motorcycle is also less visible than a car due to its narrower profile, and offers far less protection by exposing its rider to other traffic and the elements. All these risks can be managed through study, training, and practice.

PREPARING TO RIDE

What you do before you start a trip goes a long way toward determining whether or not you'll get where you want to go safely. Before taking off on any trip, a safe rider makes a point to:

1. **Wear the right gear.**
2. **Become familiar with the motorcycle.**
3. **Check the motorcycle equipment.**
4. **Be a responsible rider.**

WEAR THE RIGHT GEAR

When you ride, your gear is “right” if it protects you. In any crash, you have a far better chance of avoiding serious injuries if you wear:

- **A DOT compliant helmet.**
- **Face or eye protection.**
- **Protective clothing.**

Helmet Use

Crashes can occur — particularly among untrained, beginning riders. And one out of every five motorcycle crashes results in head or neck injuries. Head injuries are just as severe as neck injuries — and far more common. Crash analyses show that head and neck injuries account for a majority of serious and fatal injuries to motorcyclists. Research also shows that, with few exceptions, head and neck injuries are reduced by properly wearing a quality helmet.

Some riders don't wear helmets because they think helmets will limit their view to the sides. Others wear helmets only on long trips or when riding at high speeds. But, here are some facts to consider:

- **A DOT-compliant helmet** lets you see as far to the sides as necessary. A study of more than 900 motorcycle crashes, where 40% of the riders wore helmets, did not find even one case in which a helmet kept a rider from spotting danger.

- **Most crashes happen** on short trips (less than five miles long), just a few minutes after starting out.
- **Most riders** are riding slower than 30 mph when a crash occurs. At these speeds, helmets can cut both the number and the severity of head injuries by half.

No matter what the speed, helmeted riders are three times more likely to survive head injuries than those not wearing helmets at the time of the crash. The single most important thing you can do to improve your chances of surviving a crash is to wear a securely-fastened, quality helmet.

Helmet Selection

There are two primary types of helmets, providing two different levels of coverage: three-quarter and full face.

Whichever style you choose, you can get the most protection by making sure that the helmet:

- **Is designed to meet U.S.** Department of Transportation (DOT) and state standards. Helmets with a label from the Snell Memorial Foundation also give you an assurance of quality.
- **Fits snugly**, all the way around.
- **Has no obvious defects** such as cracks, loose padding or frayed straps.

PREPARING TO RIDE

Whatever helmet you decide on, keep it securely fastened on your head when you ride. Otherwise, if you are involved in a crash, it's likely to fly off your head before it gets a chance to protect you.

Eye and Face Protection

A plastic shatter-resistant faceshield can help protect your whole face in a crash. It also protects you from wind, dust, dirt, rain, insects and pebbles thrown up from cars ahead. These problems are distracting and can be painful. If you have to deal with them, you can't devote your full attention to the road.

Goggles protect your eyes, though they won't protect the rest of your face like a faceshield does. A windshield is not a substitute for a faceshield or goggles. Most windshields will not protect your eyes from the wind. Neither will eyeglasses or sunglasses. Glasses won't keep your eyes from watering, and they might blow off when you turn your head while riding.

To be effective, eye or faceshield protection must:

- **Be free** of scratches.
- **Be resistant** to penetration.
- **Give a clear view** to either side.
- **Fasten securely**, so it does not blow off.
- **Permit air** to pass through, to reduce fogging.
- **Permit enough room** for eyeglasses or sunglasses, if needed.
Tinted eye protection should not be worn when little light is available.

HELMETS



**THREE-QUARTER
OR OPEN-FACE**



FULL-FACE

Clothing

The right clothing protects you in a collision. It also provides comfort, as well as protection from heat, cold, debris and hot and moving parts of the motorcycle. It can also make you more visible to others.

- **Jacket and pants** should cover arms and legs completely. They should fit snugly enough to keep from flapping in the wind, yet loosely enough to move freely. Leather offers the most protection. Sturdy synthetic material provides a lot of protection as well. Wear a jacket even in warm weather to prevent dehydration. Many are designed to protect without getting you overheated, even on summer days. Some riders choose jackets and pants with rigid "body armor" inserts in critical areas for additional protection.
- **Boots or shoes** should be high and sturdy enough to cover your ankles and give them support. Soles should be made of hard, durable, slip-resistant material. Keep heels short so they do not catch on rough surfaces. Tuck in laces so they won't catch on your motorcycle.

PREPARING TO RIDE

- **Gloves** allow a better grip and help protect your hands in a crash. Your gloves should be made of leather or similar durable material.
- **Hearing protection** reduces noise while allowing you to hear important sounds such as car horns or sirens. Long term exposure to engine and wind noise can cause permanent hearing damage even if you wear a full face helmet. Whether you choose disposable foam plugs or reusable custom molded devices, be sure you adhere to state laws regarding hearing protection.

In cold or wet weather, your clothes should keep you warm and dry, as well as protect you from injury. You cannot control a motorcycle well if you are numb. Riding for long periods in cold weather can cause severe chill and fatigue. A winter jacket should resist wind and fit snugly at the neck, wrists and waist. Good-quality rainsuits designed for motorcycle riding resist tearing apart or ballooning up at high speeds.

CLOTHING



KNOW YOUR MOTORCYCLE

There are plenty of things on the highway that can cause you trouble. Your motorcycle should not be one of them. To make sure that your motorcycle won't let you down:

- **Start** with the right motorcycle for you.
- **Read** the owner's manual.
- **Be familiar** with the motorcycle controls.
- **Check** the motorcycle before every ride.
- **Keep** it in safe riding condition between rides.
- **Avoid** add-ons and modifications that make your motorcycle harder to handle.

The Right Motorcycle For You

First, make sure your motorcycle is right for you. It should "fit" you. Your feet should reach the ground while you are seated on the motorcycle, and the controls should be easy to operate. Smaller motorcycles are usually easier for beginners to operate.

At a minimum, your street-legal motorcycle should have:

- **Headlight, taillight and brakelight.**

I Test Yourself

A plastic shatter-resistant face shield:

- A. Is not necessary if you have a windshield
- B. Only protects your eyes
- C. Helps protect your whole face
- D. Does not protect your face as well as goggles

Answer - page 52

PREPARING TO RIDE

- Front and rear brakes.
- Turn signals.
- Horn.
- Two mirrors.

Borrowing and Lending

Borrowers and lenders of motorcycles, beware. Crashes are more likely to occur among beginning riders — especially in the first months of riding. Riding an unfamiliar motorcycle adds to the problem. If you borrow a motorcycle, get familiar with it in a controlled area. And if you lend your motorcycle to friends, make sure they are licensed and know how to ride before allowing them out into traffic.

No matter how experienced you may be, ride extra carefully on any motorcycle that's new or unfamiliar to you. More than half of all crashes involve riders with less than five months of experience on their motorcycle.

Get Familiar with the Motorcycle Controls

Make sure you are completely familiar with the motorcycle before you take it out on the street. Be sure to review the owner's manual. This is particularly important if you are riding a borrowed motorcycle.

If you are going to use an unfamiliar motorcycle:

- **Make all the checks** you would on your own motorcycle.
- **Find out where everything is**, particularly the turn signals, horn, headlight switch, fuel-supply valve and engine cut-off switch. Find and operate these items without having to look for them.

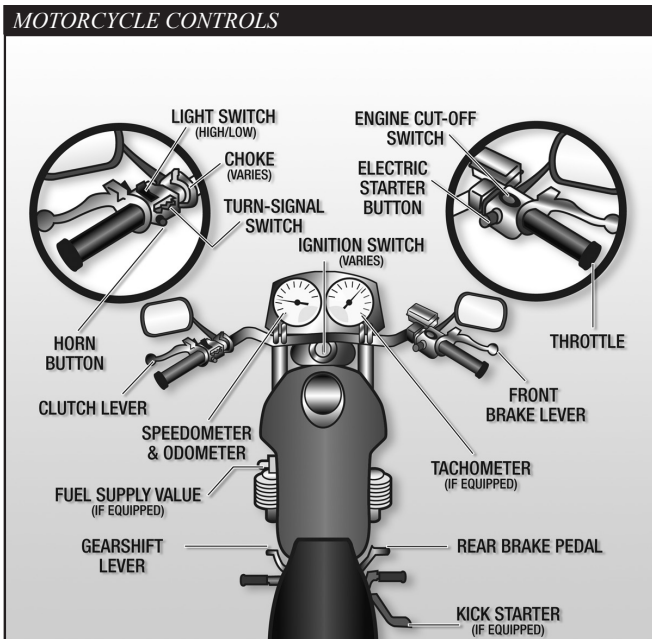

PREPARING TO RIDE

- **Know the controls.** Work the throttle, clutch, brakes, and shifter a few times before you start riding.
- **Ride very cautiously** and be aware of surroundings. Accelerate gently, take turns more slowly and leave extra room for stopping.

Check Your Motorcycle

A motorcycle needs more frequent attention than a car. A minor technical failure on a car is seldom more than an inconvenience for the driver. The same failure on a motorcycle may result in a crash or having to leave your motorcycle parked on the side of the road. If anything's wrong with your motorcycle, you'll want to find out about it before you get in traffic.

The primary source of information about how a motorcycle should be inspected and maintained is its owner's manual. Be sure to absorb all of its important information. A motorcycle will continue to ride like new if it is properly maintained and routine inspections become part of its maintenance cycle.

A pre-ride inspection only takes a few minutes and should be done before every ride to prevent problems. It's quick and easy to check the critical components and should be as routine and automatic as checking the weather forecast before heading out for the day. A convenient reminder developed by MSF is T-CLOCSSM. There is a T-CLOCS "tear-out" sheet at the back of this manual for you to keep with you when you ride. A T-CLOCS inspection should be conducted before every ride, and includes checks of:

T — Tires and Wheels

- Check tire inflation pressure, treadwear and general condition of sidewalls and tread surface.

- Try the front and rear brake levers one at a time. Make sure each feels firm and holds the motorcycle when fully applied.

C — Controls

- Make sure the clutch and throttle operate smoothly. The throttle should snap back to fully closed when released. The clutch should feel tight and should operate smoothly.
- Try the horn. Make sure it works.
- Clean and adjust your mirrors before starting. It's difficult to ride with one hand while you try to adjust a mirror. Adjust each mirror so you can see the lane behind and as much as possible of the lane next to you. When properly adjusted, a mirror may show the edge of your arm or shoulder – but it's the road behind you and to the side that are most important.

L — Lights and Electrics

- Check both headlight and taillight. Test your switch to make sure both high and low beams work.
- Turn on both right and left hand turn signals. Make sure all lights are working properly.
- Try both brakes and make sure each one turns on the brake light.

O — Oil and Other Fluids

- Check engine oil and transmission fluid levels.
- Check the brake hydraulic fluid and coolant level weekly.
- Be sure your fuel valve is open before starting out. With the fuel valve closed, your motorcycle may start with only the fuel that is still in the lines, but will stall once the lines are empty.

PREPARING TO RIDE

- Look underneath the motorcycle for signs of an oil or fuel leak.

C — Chassis

- Check the front suspension. Ensure there is no binding. The rear shocks and springs should move smoothly.
- Be sure the chain is adjusted according to the manufacturer's specifications and that the sprockets are not worn or damaged.

S — Stands

- Ensure the side stand operates smoothly and that the spring holds it tightly in the up position. If equipped, the center stand should also be held firmly against the frame whenever the motorcycle is moving.

Additionally, regular maintenance such as tune-ups and oil changes are as important for a motorcycle as routine checkups by your doctor are for you. Wear and tear is normal with use; routine maintenance will help prevent costly breakdowns. The schedule for regular upkeep for motorcycle parts and controls is contained in your motorcycle's owner's manual.

KNOW YOUR RESPONSIBILITIES

"Accident" implies an unforeseen event that occurs without fault or negligence. In traffic, that is not the case. In fact, most people involved in a crash can claim some responsibility for what takes place.

Consider a situation where someone decides to drive through an intersection on a yellow light turning red. Your light turns green. You pull into the intersection without checking for possible traffic. That is all it takes for the two of you to crash. It was the driver's responsibility to stop, and it was your responsibility to look before pulling out. Both of you are at fault.

Someone else might be the first to start the chain of events leading to a crash, but it doesn't leave any of us free of responsibility.

As a rider you can't be sure that other operators will see you or yield the right of way. To lessen your chances of a crash occurring:

- **Be visible** — wear proper clothing, use your headlight, ride in the best lane position to see and be seen.
- **Communicate your intentions** — use the proper signals, brake light and lane position.
- **Maintain an adequate space cushion** — when following, being followed, lane sharing, passing and being passed.
- **Search your path** of travel 12 seconds ahead.
- **Identify and separate hazards.**
- **Be prepared to act** — remain alert and know how to carry out proper crash-avoidance skills.

Blame doesn't matter when someone is injured in a crash. The ability to ride aware, make critical decisions and carry them out separates responsible riders from the rest. Remember, it is up to you to keep from being the cause of, or an unprepared participant in, any crash.

2

Test Yourself

More than half of all crashes:

- A. Occur at speeds greater than 35 mph
- B. Happen at night
- C. Are caused by worn tires
- D. Involve riders who have ridden their motorcycles less than six months

Answer - page 52

RIDE WITHIN YOUR ABILITIES

This manual cannot teach you how to control direction, speed or balance. That's something you can learn only through practice, preferably in a formal course of instruction like an MSF *RiderCourse*. But control begins with knowing your abilities and riding within them, along with knowing and obeying the rules of the road.

BASIC VEHICLE CONTROL

Body Position

To control a motorcycle well:

- **Posture** — Position yourself comfortably so you are able to operate all the controls and can use your arms to steer the motorcycle, rather than to hold yourself up. This helps you bond with your motorcycle and allows you to react quickly to hazards.
- **Seat** — Sit far enough forward so that arms are slightly bent when you hold the handgrips. Bending your arms permits you to press on the handlebars without having to stretch.
- **Hands** — Hold the handgrips firmly to keep your grip over rough surfaces. Start with your right wrist flat. This will help you keep from accidentally using too much throttle. Also, adjust the handlebars so your hands are even with or below your elbows. This permits you to use the proper muscles for precision steering.

HOLDING HANDLEGRIPS

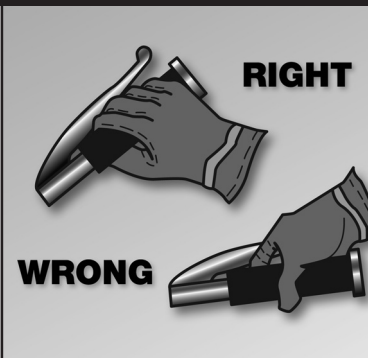

- **Knees** — Keep your knees against the gas tank to help you keep your balance as the motorcycle turns.
- **Feet** — Keep your feet firmly on the footrests to maintain balance. Don't drag your feet. If your foot catches on something, you could be injured and it could affect your control of the motorcycle. Keep your feet near the controls so you can get to them fast if needed. Also, don't let your toes point downward — they may get caught between the road and the footrests.

Shifting Gears

There is more to shifting gears than simply getting the motorcycle to pick up speed smoothly. Learning to use the gears when downshifting, turning or starting on hills is equally important for safe motorcycle operation.

The gearshift lever is located in front of the left footrest and is operated by the left foot. To shift "up" to a higher gear, position your foot under the shift lever and lift. To downshift, press the shift lever down. The shift lever changes one gear each time it is lifted or pressed down. Whenever the lever is released, spring loading returns it to center, where the mechanism resets for the next shift up or down. A typical gear pattern is 1-N-2-3-4-5. The N is for neutral, which is selected by either a "half lift" from 1st gear or a "half press" from 2nd gear. Most motorcycles have five gears, but some have four or six gears.

RIDE WITHIN YOUR ABILITIES

As your motorcycle increases speed, you will need to shift up to a higher gear. Shift up well before the engine RPM reaches its maximum recommended speed. As a general rule, shift up soon

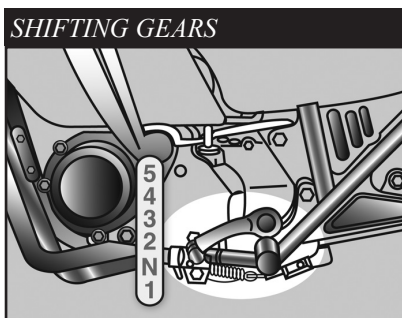

enough to avoid over-revving the engine, but not so soon to cause the engine to lug.

When upshifting, use a 3-step process: 1) Roll off the throttle as you squeeze the clutch lever, 2) lift the shift lever firmly as far as it will go, 3) smoothly ease out the clutch and adjust the throttle. Once the shift is completed, release the shift lever to permit it to reset for the next shift.

You should shift down through the gears with the clutch as you slow or stop, and can also shift down when you need more power to accelerate.

Make certain you are riding slowly enough when you shift into a lower gear. If not, the motorcycle will lurch, and the rear wheel may skid. When riding downhill or shifting into first gear you may need to use the brakes to slow enough before downshifting safely.

When downshifting, use a 3-step process: 1) Roll off the throttle as you squeeze the clutch lever, 2) press the shift lever down firmly, 3) ease out the clutch lever as you roll on the throttle.

Once the shift is completed, release the shift lever to permit it to reset for the next shift. Rolling on the throttle slightly while smoothly easing out the clutch can help the engine come up to speed more quickly and make the downshift smoother. Shifting to a lower gear causes an effect similar to using the brakes. This is known as engine braking. To use engine braking, shift down one gear at a time and ease out the clutch through the friction zone between each downshift. Keep the clutch in the friction zone until the engine speed stabilizes. Then ease out the lever fully until ready for the next downshift. Usually you shift gears one at a time, but it is possible to shift through more than one gear while the clutch is squeezed.

Remain in first gear while you are stopped so that you can move out quickly if you need to.

Work toward a smooth, even clutch release, especially when downshifting. It is best to change gears before entering a turn. However, sometimes shifting while in the turn is necessary. If so, remember to do so smoothly. A sudden change in power to the rear wheel can cause a skid.

Braking

Improper braking technique remains a significant contributing factor in many motorcycle crashes. Your motorcycle has two brake controls: one for the front wheel and one for the rear wheel. Always use both brakes every time you slow or stop. The front brake is more powerful and can provide at least 70% of your total stopping power. The front brake is safe to use if you use it properly.

RIDE WITHIN YOUR ABILITIES

Maximum straight-line braking is accomplished by fully applying both front and rear brakes without locking either wheel.

To do this:

- **Squeeze the front brake** smoothly, firmly and with progressively more force. Do not grab the brake lever or use abrupt pressure.
- **As the motorcycle's weight** transfers forward, more traction becomes available at the front wheel, so the front brake can be applied harder after braking begins.
- **Keep your knees against the tank** and your eyes up, looking well ahead. This helps you stop the motorcycle in a straight line.
- **Apply light-to-lighter pressure** to the rear brake pedal to prevent a rear wheel skid. As weight transfers forward less traction is available at the rear. Use less rear brake pressure.

Using both brakes for even “normal” stops will permit you to develop the proper habit or skill of using both brakes properly in an emergency. Squeeze the front brake and press down on the rear. Grabbing at the front brake or jamming down on the rear can cause the brakes to lock, resulting in control problems.

Braking in a Corner

Any time a motorcycle is leaned over, the amount of traction available for braking is reduced. The greater the lean angle, the more the possibility of the tires losing traction.

To stop as quickly and as safely as possible in a curve, and depending on road and traffic conditions, try to get the motorcycle as perpendicular to the road as possible, then brake. If conditions do not allow, brake smoothly and gradually,

but do not apply as much braking force as you would if the motorcycle were straight up. As you slow, you can reduce your lean angle, and as more traction becomes available for braking, you can more firmly apply the brakes, so that by the time the motorcycle is stopped, the motorcycle is straight up, and the handlebars are squared.

Linked and Integrated Braking Systems

Some motorcycles have linked braking which connects the front and rear brakes on the motorcycle and applies braking pressure to both brakes when either the front lever or rear pedal is applied. An integrated braking system is a variation of the linked system in which partial front braking is applied whenever the rear brake is activated. Consult your owner's manual for a detailed explanation on the operation and effective use of these systems.

Anti-Lock Braking Systems (ABS)

ABS is designed to prevent wheel lock-up and avoid skids when stopping in straight-line, panic situations. ABS operates when maximum pressure on both the front and rear brake controls is applied. If electronic sensors detect the possibility of a wheel lock, brake hydraulic pressure, is released then reapplied to maintain maximum braking effectiveness.

The system is capable of releasing and reapplying pressure more than 15 times per second.

RIDE WITHIN YOUR ABILITIES

Turning

Approach turns and curves with caution. Riders often try to take curves or turns too fast. When they can't hold the turn, they end up crossing into another lane of traffic or going off the road. Or, they overreact and brake too hard, causing a skid and loss of control.

Use four steps for better control:

- **SLOW** — Reduce speed before the turn by closing the throttle and, if necessary, applying both brakes.
- **LOOK** — Look through the turn to where you want to go. Turn just your head, not your shoulders, and keep your eyes level with the horizon.
- **PRESS** — To turn, the motorcycle must lean. To lean the motorcycle, press on the handgrip in the direction of the turn. Press left handgrip — lean left — go left. Press right handgrip — lean right — go right. The higher the speed in a turn, or the sharper the turn, the greater the lean angle needs to be.
- **ROLL** — Roll on the throttle to maintain or slightly increase speed. This helps stabilize the motorcycle.

In normal turns, the rider and the motorcycle should lean together at the same angle.

NORMAL TURNS



In slow, tight turns, counter-balance by leaning the motorcycle only and keeping your body straight.

SLOW, TIGHT TURNS



3

Test Yourself

When riding, you should:

- Turn your head and shoulders to look through turns
- Keep your arms straight
- Keep your knees away from the gas tank
- Turn just your head and eyes to look where you are going

Answer - page 52

RIDE WITHIN YOUR ABILITIES

KEEPING YOUR DISTANCE

The best protection you can have is distance — a “cushion of space” — separating yourself from other vehicles on the roadway. This will provide you with a clear view of emerging traffic situations, so that if someone else makes a mistake, you will have:

- More time to respond.
- More space to maneuver, including an escape route if necessary.

Lane Positions

Successful motorcyclists know that they are safer when clearly seen. In some ways the size of the motorcycle can work to your advantage. Each traffic lane gives a motorcycle three paths of travel, as indicated in the illustration.

Your lane position should help you:

- Increase your ability to see and be seen.
- Avoid others' blind spots.
- Avoid surface hazards.
- Protect your lane from other drivers.
- Communicate your intentions.

- Avoid windblast from other vehicles.

- Provide an escape route.

- Set up for turns.

Many motorcyclists consider the left third of the lane — the left tire track of automobiles — to be their default lane position. You should then consider varying your lane position as conditions warrant, keeping mind that no portion of the lane need be avoided — including the center.

You should position yourself in the portion of the lane where you are most likely to be seen and you can maintain a space cushion around you. Change your position as traffic situations change. Ride in path 2 or 3 if vehicles and other potential problems are on your left only. Remain in path 1 or 2 if hazards are on your right only. If vehicles are being operated on both sides of you, the center of the lane, path 2, is usually your best option.

Remember, the center third of the lane is the place where debris and oil drippings from cars collect and where hazards such as manhole covers are located. Unless the road is wet, the

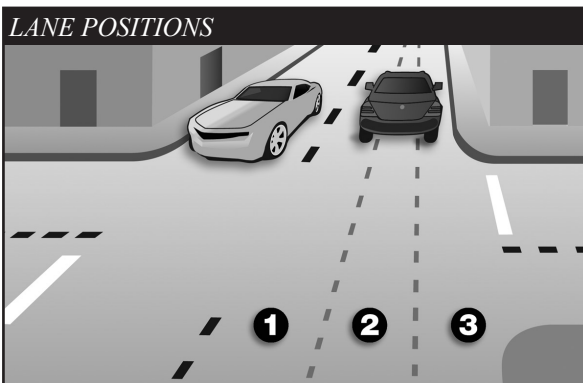

RIDE WITHIN YOUR ABILITIES

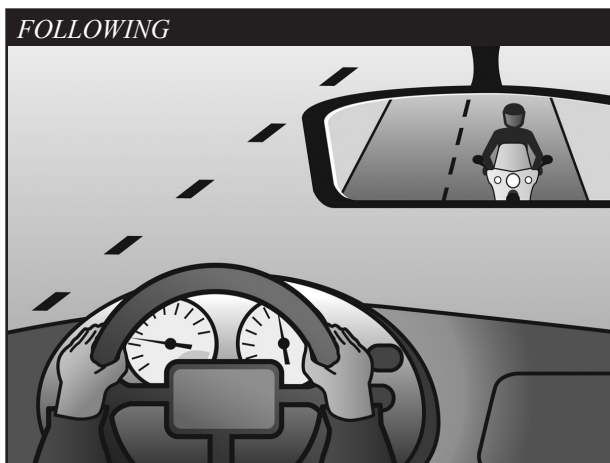

average center strip permits adequate traction to ride on safely. You can operate to the left or right of the grease strip and still be within the center third of the traffic lane. Avoid riding on big buildups of oil and grease usually found at busy intersections or tollbooths.

Experienced riders rely on their own best judgment and instincts. One absolute, however, is to avoid riding in another vehicle's blind spot.

Following Another Vehicle

"Following too closely" is a factor in crashes involving motorcyclists. In traffic, motorcycles need as much distance to stop as cars. Normally, a **minimum of two seconds** distance should be maintained behind the vehicle ahead.

To gauge your following distance:

- **Pick out a marker**, such as a pavement marking or lamppost, on or near the road ahead.
- **When the rear bumper** of the vehicle ahead passes the marker, count off the seconds: "one-thousand-one, one-thousand-two."

- **If you reach the marker** before you reach "two," you are following too closely.

A two-second following distance leaves a minimum amount of space to stop or swerve if the driver ahead stops suddenly. It also permits a better view of potholes and other hazards in the road.

A larger cushion of space is needed if your motorcycle will take longer than normal to stop. If the pavement is slippery, if you cannot see through the vehicle ahead, or if traffic is heavy and someone may squeeze in front of you, open up a three-second or more following distance.

Keep well behind the vehicle ahead even when you are stopped. This will make it easier to get out of the way if someone bears down on you from behind. It will also give you a cushion of space if the vehicle ahead starts to back up for some reason.

RIDE WITHIN YOUR ABILITIES

When behind a car, ride where the driver can see you in the rearview mirror. Riding in the center portion of the lane should put your image in the middle of the rearview mirror — where a driver is most likely to see you.

Riding at the far side of a lane may permit a driver to see you in a sideview mirror. But remember that most drivers don't look at their sideview mirrors nearly as often as they check the rearview mirror. If the traffic situation allows, the center portion of the lane is usually the best place for you to be seen by the drivers ahead and to prevent lane sharing by others.

Being Followed

Speeding up to lose someone following too closely only ends up with someone tailgating you at a higher speed.

A better way to handle tailgaters is to get them in front of you. When someone is following too closely, change lanes and let them pass. If you can't do this, slow down and open up extra space ahead of you to allow room for both you and the tailgater to stop. This will also encourage them to pass. If they don't pass, you will have given yourself and the tailgater more time and space to react in case an emergency does develop ahead.

Passing and Being Passed

Passing and being passed by another vehicle is not much different than with a car. However, visibility is more critical. Be sure other drivers see you, and that you see potential hazards.

Passing

1. **Ride in the left portion** of the lane at a safe following distance to increase your line of sight and make you more visible. Signal and check for oncoming traffic. Use your mirrors and turn your head to look for traffic behind.
2. **When safe**, move into the left lane and accelerate. Select a lane position that doesn't crowd the car and provides space to avoid hazards in your lane.
3. **Ride through the blind spot** as quickly as possible.
4. **Signal again**, and complete mirror and headchecks before returning to your original lane and then cancel the signal.

Remember, passes must be completed within posted speed limits, and only where permitted. Know your signs and road markings!

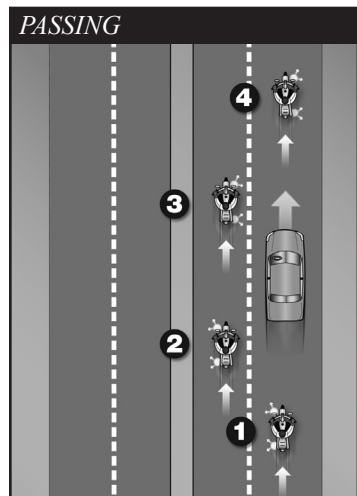

RIDE WITHIN YOUR ABILITIES

Being Passed

When you are being passed from behind, stay in the center portion of your lane. Riding close to the passing vehicle could put you in a hazardous situation.

Avoid being hit by:

- **The other vehicle** — A slight mistake by you or the passing driver could cause a sideswipe.
- **Extended mirrors** — Some drivers forget that their mirrors hang out farther than their fenders.
- **Objects thrown from windows** — Even if the driver knows you're there, a passenger may not see you and might toss something on you or the road ahead of you.
- **Blasts of wind from larger vehicles** — They can affect your control. You have more room for error if you are in the middle portion when hit by this blast than if you are on either side of the lane.

Do not move into the portion of the lane farthest from the passing vehicle. It might invite the other driver to cut back into your lane too early.

Lane Sharing

Cars and motorcycles need a full lane to operate safely. Lane sharing is usually prohibited.

Riding between rows of stopped or moving cars in the same lane can leave you vulnerable to the unexpected. A hand could come out of a window; a door could open; a car could turn suddenly. Discourage lane sharing by others. Keep a center-portion position whenever drivers might be tempted to squeeze by you. Drivers are most tempted to do this:

- **In heavy**, bumper-to-bumper traffic.
- **When they** want to pass you.
- **When you** are preparing to turn at an intersection.
- **When you** are moving into an exit lane or leaving a highway.

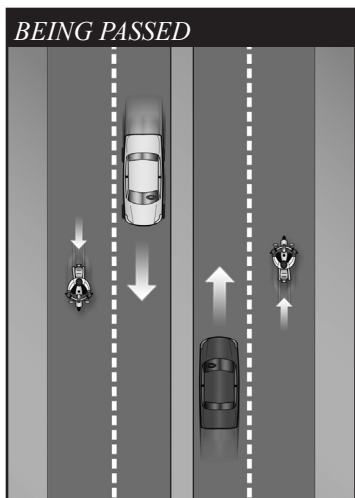

4

Test Yourself

Usually, a good way to handle tailgaters is to:

- A. Change lanes and let them pass
- B. Use your horn and make obscene gestures
- C. Speed up to put distance between you and the tailgater
- D. Ignore them

Answer - page 52

RIDE WITHIN YOUR ABILITIES

Merging Cars

Drivers on an entrance ramp may not see you on the highway. Give them plenty of room. Change to another lane if one is open. If there is no room for a lane change, adjust speed to open up space for the merging driver.

Cars Alongside

Do not ride next to cars or trucks in other lanes if you do not have to. You might be in the blind spot of a car in the next lane, which could switch into your lane without warning. Cars in the next lane also block your escape if you come upon danger in your own lane. Speed up or drop back to find a place clear of traffic on both sides.

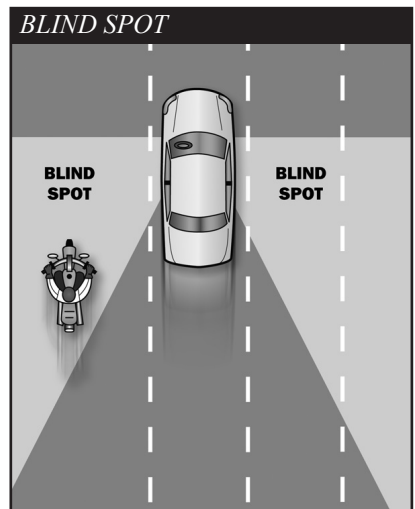
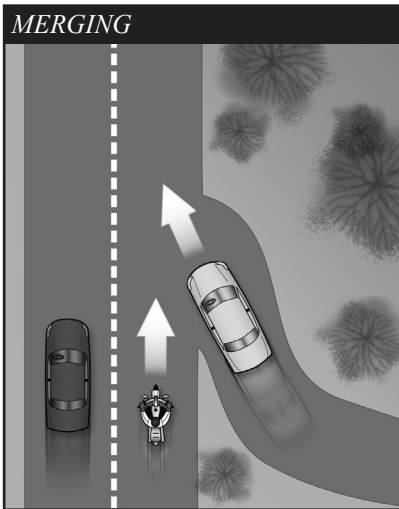

RIDE WITHIN YOUR ABILITIES

SEE

Good, experienced riders are always aware of what is going on around them. They reduce their risk by using MSF's three-step SEESM strategy:

- Search
- Evaluate
- Execute

SEE will help you assess what is going on in traffic so you can plan and implement the safest course of action as traffic situations change. Let's look at each of these steps.

Search

How assertively you search, and how much time and space you have, can eliminate or minimize risk. As you search, focus on finding potential escape routes, especially in or around intersections, shopping areas and school and construction zones.

One way to search is to use your "RiderRadar" to aggressively scan the environment ahead of you, to the sides, and behind you to avoid potential hazards even before they arise. There are three "lead times" experienced riders consider. First, be alert and scan for hazards that are about 2 seconds ahead of you, or within your following distance. Scanning your 4-second immediate path can allow you time for a quick response if something should go wrong. Anything that is within 4 seconds of your path is considered immediate because 4 seconds is considered enough time and space to swerve and/or brake for fixed hazards or for someone or something entering your path of travel.

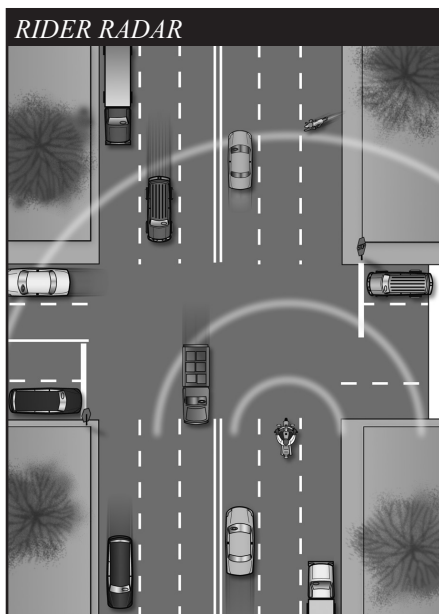

Finally, experienced riders search for hazards that are further out, looking ahead to an area it would take about 12 seconds to reach. This provides time to prepare for a situation before it becomes immediate.

Using the SEE strategy will help you to **Search** for a variety of factors such as:

- **Oncoming traffic** that may turn left in front of you.
- **Traffic** coming from the left and from the right.
- **Traffic** approaching from behind.
- **Hazardous** road conditions that require you to be alert, especially in areas with limited visibility. Visually "busy" surroundings could hide you and your motorcycle from others.

RIDE WITHIN YOUR ABILITIES

Evaluate

Evaluate means to think about how hazards can interact to create risks for you. Anticipate potential problems and have a plan to reduce risks, particularly when faced with:

- **Road and surface characteristics** such as potholes, guardrails, bridges, telephone poles and trees that won't move into your path, but may influence your riding strategy.
- **Traffic control devices** including traffic signals, warning signs, and pavement markings, which will require you to carefully evaluate circumstances ahead.
- **Vehicles and other traffic** that may move into your path and increase the likelihood of a crash. Think about your time and space requirements in order to maintain a margin of safety, and give yourself time to react if an emergency arises.

Execute

Finally, **Execute** your decision. To create more space and minimize harm from any hazard:

- **Communicate** your presence with lights and/or horn.
- **Adjust your speed** by accelerating, stopping or slowing.
- **Adjust your position** and/or direction by swerving, changing lanes, or moving to another position within your lane.

Apply the old adage “one step at a time” to handle two or more hazards. Adjust speed to permit two hazards to separate. Then deal with them one at a time as single hazards. Decision-making becomes more complex with three or more hazards. Evaluate the consequences of each and give equal distance to the hazards.

In potential high-risk areas, such as intersections, shopping areas and school and construction zones, cover the clutch and both brakes to reduce the time you need to react.

INTERSECTIONS

The greatest potential for conflict between you and other traffic is at intersections. An intersection can be in the middle of an urban area or at a driveway on a residential street — anywhere traffic may cross your path of travel. Over one-half of motorcycle/car crashes are caused by drivers entering a rider's right-of-way. Cars that turn left in front of you, including cars turning left from the lane on your right, and cars on side streets that pull into your lane, are the biggest dangers. Your use of SEE at intersections is critical.

5

Test Yourself

To reduce your reaction time, you should:

- A. Ride slower than the speed limit
- B. Cover the clutch and the brakes
- C. Shift into neutral when slowing
- D. Pull in the clutch when turning

Answer - page 52

RIDE WITHIN YOUR ABILITIES

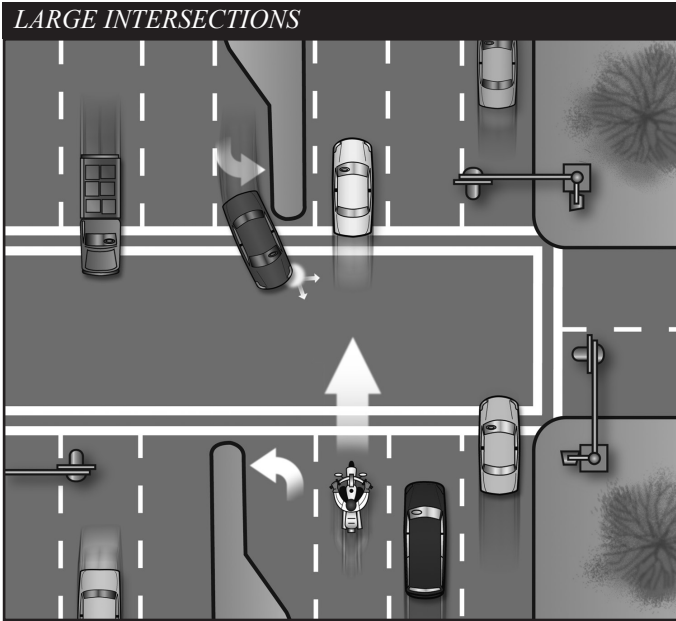

There are no guarantees that others see you. Never count on “eye contact” as a sign that a driver will yield. Too often, a driver looks right at a motorcyclist and still fails to “see” him or her. The only eyes that you can count on are your own. If a car can enter your path, assume that it will. Good riders are always “looking for trouble” — not to get into it, but to stay out of it.

Increase your chances of being seen at intersections. Ride with your headlight on and in a lane position that provides the best view of oncoming traffic. Provide a space cushion around the motorcycle that permits you to take evasive action. When approaching an intersection where a vehicle driver is preparing to cross your path, slow down and select a lane position to increase your visibility to that driver. Cover the clutch lever and both brakes to reduce reaction time. As you enter the intersection,

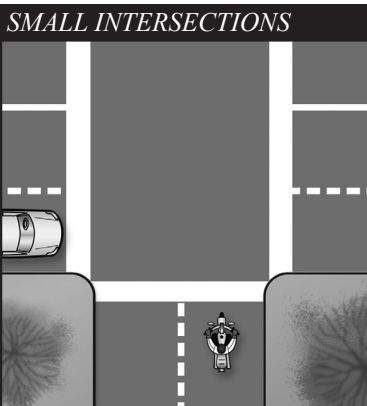

6 *Test Yourself*

Making eye contact with other drivers:

- A. Is a good sign they see you
 - B. Is not worth the effort it takes
 - C. Doesn't mean that the driver will yield
 - D. Guarantees that the other driver will yield to you
- Answer - page 52

RIDE WITHIN YOUR ABILITIES

move away from the vehicle. Do not change speed or position radically, as drivers might think you are preparing to turn. Be prepared to brake hard and hold your position if an oncoming vehicle turns in front of you, especially if there is other traffic around you. This strategy should also be used whenever a vehicle in the oncoming lane of traffic is signaling for a left turn, whether at an intersection or not.

Blind Intersections

If you approach a blind intersection, move to the portion of the lane that will bring you into another driver's field of vision at the earliest possible moment. In this picture, the rider has moved to the left portion of the lane — away from the parked car — so the driver on the cross street can see him as soon as possible.

Remember, the key is to see as much as possible and remain visible to others while protecting your space.

If you have a stop sign or stop line, stop there first. Then edge forward and stop again, just short of where the cross-traffic lane meets your lane. From that position, lean your body forward and look around buildings, parked cars or bushes to see if anything is coming. Just make sure your front wheel stays out of the cross lane of travel while you're looking.

Passing Parked Cars

When passing parked cars, stay toward the left of your lane. You can avoid problems caused by doors opening, drivers getting out of cars or people stepping from between cars. If oncoming traffic is present, it is usually best to remain in the center-lane position to maximize your space cushion.

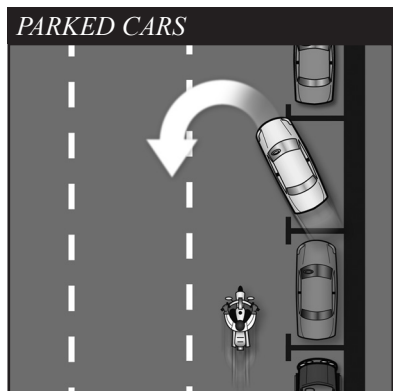
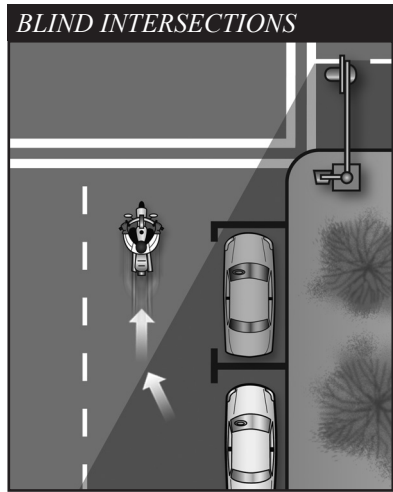

RIDE WITHIN YOUR ABILITIES

A bigger problem can occur if the driver pulls away from the curb without checking for traffic behind. Even if he does look, he may fail to see you.

In either event, the driver might cut into your path. Slow down or change lanes to make room for someone cutting in.

Cars making a sudden U-turn are the most dangerous. They may cut you off entirely, blocking the whole roadway and leaving you with no place to go. Since you can't tell what a driver will do, slow down and get the driver's attention. Sound your horn and continue with caution.

Parking at the Roadside

If parking in a parallel parking space next to a curb, position the motorcycle at an angle with the rear wheel to the curb. (Note: Some cities have ordinances that require motorcycles to park parallel to the curb.)

INCREASING CONSPICUITY

In crashes with motorcyclists, drivers often say that they never saw the motorcycle. From ahead or behind, a motorcycle's outline is much smaller than a car's. Also, it's hard to see something you are not looking for, and most drivers are not looking for motorcycles. More likely, they are looking through the skinny, two-wheeled silhouette in search of cars that may pose a problem to them.

Even if a driver does see you coming, you aren't necessarily safe. Smaller vehicles appear farther away and seem to be traveling slower than they actually are. It is common for drivers to pull out in front of motorcyclists, thinking they have plenty of time. Too often, they are wrong.

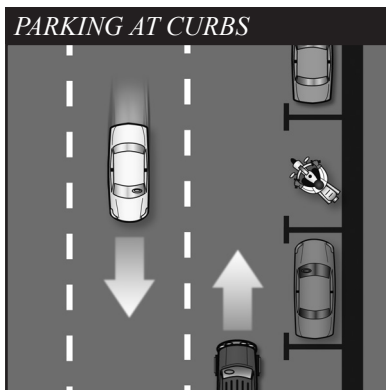

However, you can do many things to make it easier for others to recognize you and your motorcycle.

Clothing

Most crashes occur in broad daylight. Wear bright-colored clothing to increase your chances of being seen. Remember, your body is half of the visible surface area of the rider/motorcycle unit.

Bright orange, red, yellow or green jackets/vests are your best bets for being seen. Your helmet can do more than protect you in a crash. Brightly colored helmets can also help others see you.

Any bright color is better than drab or dark colors. Reflective, bright-colored clothing (helmet and jacket/vest) is best.

Reflective material on a vest and on the sides of the helmet will help drivers coming from the side to spot you. Reflective material can also be a big help for drivers coming toward you or from behind.

Headlight

The best way to help others see your motorcycle is to keep the headlight on — **at all times** (new motorcycles sold in the USA since 1978 automatically have the headlights on when running).

RIDE WITHIN YOUR ABILITIES

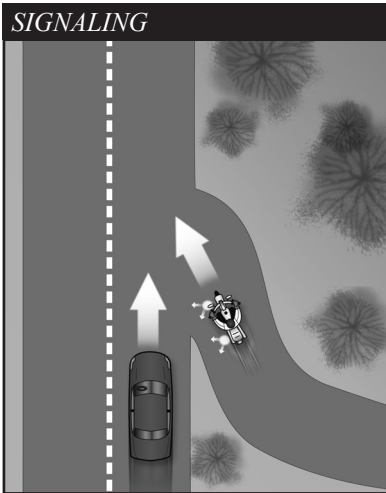

Studies show that, during the day, a motorcycle with its light on is twice as likely to be noticed. Use low beam at night and in fog.

Signals

The signals on a motorcycle are similar to those on a car. They tell others what you plan to do.

However, due to a rider's added vulnerability, signals are even more important. Use them anytime you plan to change lanes or turn. Use them even when you think no one else is around. It's the car you don't see that's going to give you the most trouble. Your signal lights also make you easier to spot. That's why it's a good idea to use your turn signals even when what you plan to do is obvious.

When you enter a freeway, drivers approaching from behind are more likely to see your signal blinking and make room for you.

Turning your signal light on before each turn reduces confusion and frustration for the traffic around you. Once you turn, make sure your signal is off or a driver may pull directly into your path, thinking you plan to turn

again. Use your signals at every turn so drivers can react accordingly. Don't make them guess what you intend to do.

Brake Light

Your motorcycle's brake light is usually not as noticeable as the brake lights on a car — particularly when your taillight is on. (It goes on with the headlight.) If the situation will permit, help others notice you by flashing your brake light before you slow down. It is especially important to flash your brake light before:

- **You slow more quickly** than others might expect (turning off a high-speed highway).
- **You slow where** others may not expect it (in the middle of a block or at an alley).

If you are being followed closely, it's a good idea to flash your brake light before you slow. The tailgater may be watching you and not see something ahead that will make you slow down. This will hopefully discourage them from tailgating and warn them of hazards ahead they may not see.

Using Your Mirrors

While it's most important to keep track of what's happening ahead, you can't afford to ignore situations behind. Traffic conditions change quickly. Knowing what's going on behind is essential for you to make a safe decision about how to handle trouble ahead.

Frequent mirror checks should be part of your normal searching routine. Make a special point of using your mirrors:

- **When you are stopped** at an intersection. Watch cars coming up from behind. If the drivers aren't paying attention, they could be on top of you before they see you.

RIDE WITHIN YOUR ABILITIES

- **Before you change lanes.** Make sure no one is about to pass you.
- **Before you slow down.** The driver behind may not expect you to slow, or may be unsure about where you will slow. For example, you signal a turn and the driver thinks you plan to turn at a distant intersection, rather than at a nearer driveway.

Most motorcycles have rounded (convex) mirrors. These provide a wider view of the road behind than do flat mirrors. They also make cars seem farther away than they really are. If you are not used to convex mirrors, get familiar with them. (While you are stopped, pick out a parked car in your mirror. Form a mental image of how far away it is. Then, turn around and look at it to see how close you came.) Practice with your mirrors until you become a good judge of distance. Even then, allow extra distance before you change lanes.

Head Checks

Checking your mirrors is not enough. Motorcycles have “blind spots” like cars. Before you change lanes, turn your head, and look to the side for other vehicles.

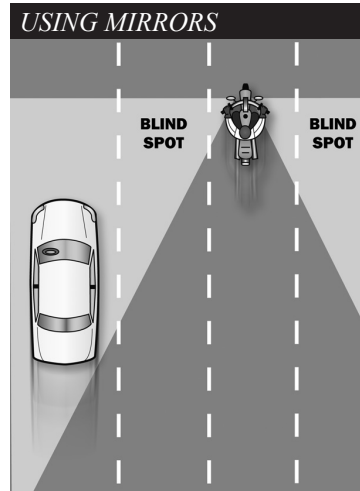

On a road with several lanes, check the far lane and the one next to you. A driver in the distant lane may head for the same space you plan to take.

Frequent head checks should be your normal scanning routine, also. Only by knowing what is happening **all around** you are you fully prepared to deal with it.

Horn

Be ready to use your horn to get someone’s attention quickly.

It is a good idea to give a quick beep before passing anyone that may move into your lane.

Here are some situations:

- **A driver** in the lane next to you is driving too closely to the vehicle ahead and may want to pass.
- **A parked car** has someone in the driver’s seat.
- **Someone is in the street**, riding a bicycle or walking.

In an emergency, sound your horn loud and long. Be ready to stop or swerve away from the danger.

7

Test Yourself

Reflective clothing should:

- A. Be worn at night
- B. Be worn during the day
- C. Not be worn
- D. Be worn day and night

Answer - page 52

RIDE WITHIN YOUR ABILITIES

Keep in mind that a motorcycle's horn isn't as loud as a car's — therefore, use it, but don't rely on it. Other strategies, like having time and space to maneuver, may be appropriate along with the horn.

Riding at Night

At night it is harder for you to see and be seen. Picking your headlight or taillight out of the car lights around you is not easy for other drivers. To compensate, you should:

- **Reduce Your Speed** — Ride even slower than you would during the day — particularly on roads you don't know well. This will increase your chances of avoiding a hazard.
- **Increase Distance** — Distances are harder to judge at night than during the day. Your eyes rely upon shadows and light contrasts to determine how far away an object is and how fast it is coming. These contrasts are missing or distorted under artificial lights at night. Open up a three-second following distance or more. And allow more distance to pass and be passed.
- **Use the Car Ahead** — The headlights of the car ahead can give you a better view of the road than even your high beam can. Taillights bouncing up and down can alert you to bumps or rough pavement.
- **Use Your High Beam** — Get all the light you can. Use your high beam whenever you are not following or meeting a car. Be visible: Wear reflective materials when riding at night.
- **Be Flexible About Lane Position.** Change to whatever portion of the lane is best able to help you see, be seen and keep an adequate space cushion.

CRASH AVOIDANCE

No matter how careful you are, there will be times when you find yourself in a tight spot. Your chances of getting out safely depend on your ability to react quickly and properly. Often, a crash occurs because a rider is not prepared or skilled in crash-avoidance maneuvers.

Know when and how to stop or swerve, two skills critical in avoiding a crash. It is not always desirable or possible to stop quickly to avoid an obstacle. Riders must also be able to swerve around an obstacle. Determining which skill is necessary for the situation is important as well.

Studies show that most crash-involved riders:

- Underbrake the front tire and overbrake the rear.
- Did not separate braking from swerving or did not choose swerving when it was appropriate.

The following information offers some good advice.

Quick Stops

To stop quickly, apply both brakes at the same time. Don't be shy about using the front brake, but don't "grab" it, either. Squeeze the brake lever firmly and progressively. If the front wheel locks, release the front brake immediately then reapply it firmly. At the same time, press down on the rear brake. If you accidentally lock the rear brake on a good traction surface, you can keep it locked until you have completely stopped; but, even with a locked rear wheel, you can control the motorcycle on a straightaway if it is upright and going in a straight line.

RIDE WITHIN YOUR ABILITIES

Stopping Quickly in a Curve

If you know the technique, using both brakes in a turn is possible, although it should be done very carefully. When leaning the motorcycle some of the traction is used for cornering. Less traction is available for stopping. A skid can occur if you apply too much brake. Also, using the front brake incorrectly on a slippery surface may be hazardous. Use caution and squeeze the brake lever, never grab.

If you must stop quickly while turning in a curve, first straighten and square the handlebars, then stop. If you find yourself in a situation that does not allow straightening first, such as when there is a danger of running off the road in a left-hand curve, or when facing oncoming traffic in a right-hand curve, apply the brakes smoothly and gradually. As you slow, you can reduce your lean angle and apply more brake pressure until the motorcycle is straight and maximum brake pressure can be applied. Always straighten

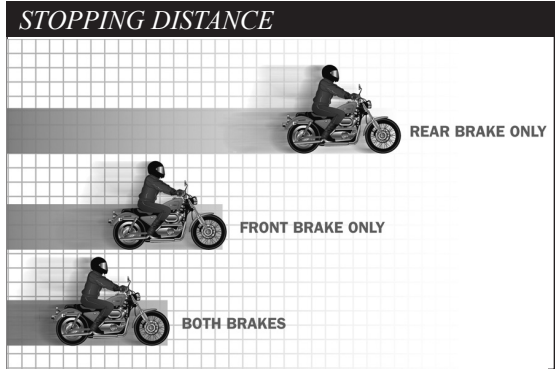

the handlebars in the last few feet of stopping to maintain your balance and remain upright.

Swerving or Turning Quickly

Sometimes you may not have enough room to stop, even if you use both brakes properly. You may encounter an unexpected object in your path, or the car ahead might squeal to a stop. The only way to avoid a crash may be to turn quickly or swerve around it. A swerve is a sudden change in direction. It can be two quick turns, or a rapid shift to the side. Apply a small amount of hand pressure to the handgrip located on the side of your

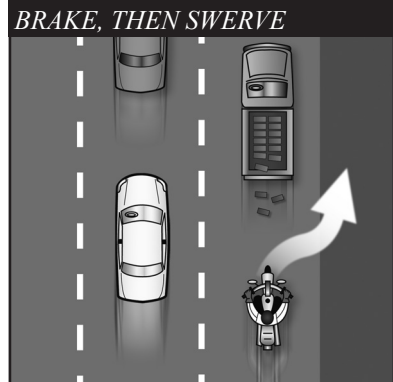

RIDE WITHIN YOUR ABILITIES

intended direction of escape. This will cause the motorcycle to lean quickly. The sharper the turn(s), the more the motorcycle must lean. Keep your body upright and allow the motorcycle to lean in the direction of the turn while keeping your knees against the tank and your feet solidly on the foot rests. Let the motorcycle move underneath you. Make your escape route the target of your vision. Press on the opposite handlegrip once you clear the obstacle to return you to your original direction of travel. To swerve to the left, press the left handlegrip, then press the right to recover. To swerve to the right, press right, then left. If braking is required, separate it from swerving. Break before or after - never while swerving.

Maximum Straight-Line Braking

Maximum straight-line braking is accomplished by fully applying front and rear brakes without locking either wheel. Keep your body centered over the motorcycle and look well ahead, not down. This will help you keep the motorcycle in as straight a line as possible, minimizing lean angle and the likelihood of the wheels losing traction.

Front-Wheel Skids

If the front wheel locks, release the front brake immediately and completely.

Reapply the brake smoothly.

CONSTANT CURVES

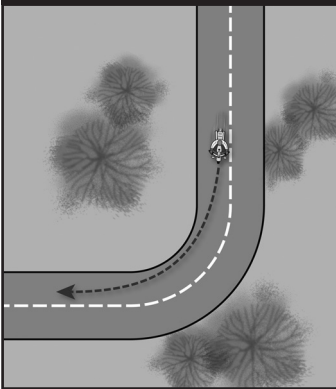

DECREASING CURVES (Tighter Turns)

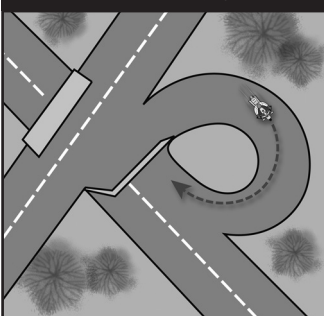

MULTIPLE CURVES

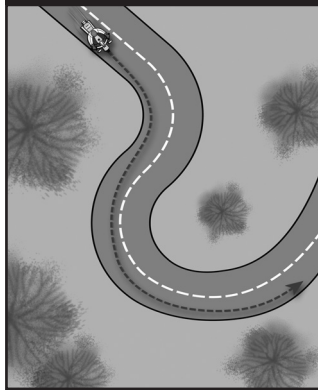

WIDENING CURVES

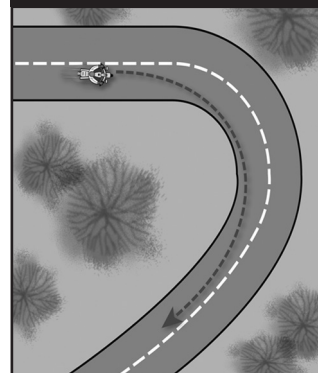

RIDE WITHIN YOUR ABILITIES

Front-wheel skids result in immediate loss of steering control and balance. Failure to fully release the brake lever immediately will result in a crash.

Rear-Wheel Skids

A skidding rear tire is a dangerous condition that can result in a violent crash and serious injury or death. Too much rear brake pressure causes rear-wheel lockup. As soon as the rear wheel locks, your ability to change direction is lost. To regain control the brake must be released. However, if the rear wheel is out of alignment with the front, there is a risk of a high-side crash. This occurs when the wheels are out of alignment and a locked rear wheel is released. The motorcycle can abruptly snap upright and tumble, throwing the rider into the air ahead of the motorcycle's path. Even slight misalignment can result in a high-side crash.

Curves

A primary cause of single-vehicle crashes is motorcyclists running wide in a curve or turn and colliding with the roadway or a fixed object. Every curve is different. Be alert to whether a curve remains constant, gradually widens, gets tighter or involves multiple turns. Ride within your skill level and posted speed limits.

Your best path may not always follow the curve of the road. Change lane position depending on traffic, road conditions and curve of the road. If no traffic is present, start at the outside of a curve to increase your line of sight and the effective radius of the turn. As you turn, move toward the inside of the curve, and as you pass the center, move to the outside to exit.

Another alternative is to move to the center of your lane before entering a curve — and stay there until you exit.

This permits you to spot approaching traffic as soon as possible. You can also adjust for traffic “crowding” the center line, or debris blocking part of your lane.

HANDLING DANGEROUS SURFACES

Your chance of falling or being involved in a crash increases whenever you ride across:

- Uneven surfaces or obstacles.
- Slippery surfaces.
- Railroad tracks.
- Grooves and gratings.

Uneven Surfaces and Obstacles

Watch for uneven surfaces such as bumps, broken pavement, potholes or small pieces of highway trash.

Try to avoid obstacles by slowing or going around them. If you must go over the obstacle, first determine if it is possible. Approach it at as close to a 90° angle as possible. Look where you want to go to control your path of travel. If you have to ride over the obstacle, you should:

- **Slow down** as much as possible before contact.
- **Make sure** the motorcycle is straight.
- **Rise slightly** off the seat with your weight on the footrests to absorb the shock with your knees and elbows, and avoid being thrown off the motorcycle.
- **Just before contact**, roll on the throttle slightly to lighten the front end.

If you ride over an object on the street, pull off the road and check your tires and rims for damage before riding any farther.

RIDE WITHIN YOUR ABILITIES

OBSTACLES

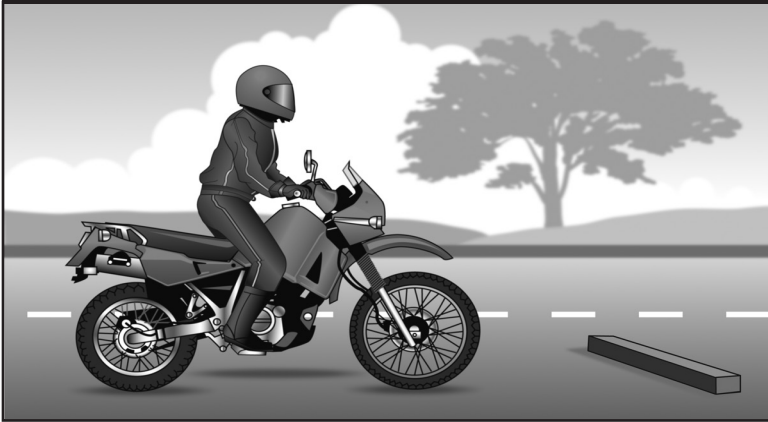

Slippery Surfaces

Motorcycles handle better when ridden on surfaces that permit good traction. Surfaces that provide poor traction include:

- **Wet pavement**, particularly just after it starts to rain and before surface oil washes to the side of the road.
- **Gravel roads**, or where sand and gravel collect.
- **Mud, leaves, snow, and ice.**
- **Lane markings (painted lines)**, steel plates and manhole covers, especially when wet.

To ride safely on slippery surfaces:

- **Reduce Speed** — Slow down before you get to a slippery surface to lessen your chances of skidding. Your motorcycle needs more distance to stop. And it is particularly important to reduce speed before entering wet curves.
- **Avoid Sudden Moves** — Any sudden change in speed or direction can cause a skid. Be as smooth as possible when you speed up, shift gears, turn or brake.

- **Use Both Brakes** — The front brake is still effective, even on a slippery surface. Squeeze the brake lever gradually to avoid locking the front wheel. Remember, gentle pressure on the rear brake.
- **The center of a lane** can be hazardous when wet. When it starts to rain, ride in the tire tracks left by cars. Often, the left tire track will be the best position, depending on traffic and other road conditions.
- **Watch for oil spots** when you put your foot down to stop or park. You may slip and fall.
- **Dirt and gravel** collect along the sides of the road — especially on curves and ramps leading to and from highways. Be aware of what's on the edge of the road, particularly when making sharp turns and getting on or off freeways at high speeds.
- **Rain dries and snow melts faster** on some sections of a road than on others. Patches of ice tend to develop in low or shaded areas and on bridges and overpasses. Wet surfaces or wet leaves are just as slippery. Ride on the least slippery portion of the lane and reduce speed.

RIDE WITHIN YOUR ABILITIES

Cautious riders steer clear of roads covered with ice or snow. If you can't avoid a slippery surface, keep your motorcycle straight up and proceed as slowly as possible. If you encounter a large surface so slippery that you must coast, or travel at a walking pace, consider letting your feet skim along

the surface. If the motorcycle starts to fall, you can catch yourself. Be sure to keep off the brakes. If possible, squeeze the clutch and coast. Attempting this maneuver at anything other than the slowest of speeds could prove hazardous.

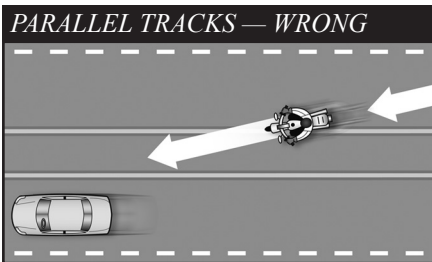
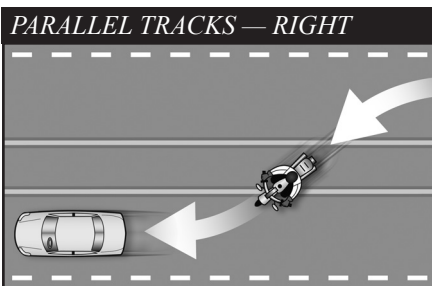
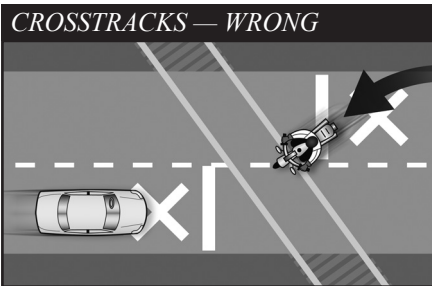
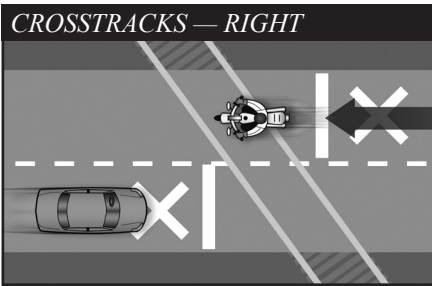

8 *Test Yourself*

The best way to stop quickly is to:

- A. Use the front brake only
- B. Use the rear brake first
- C. Throttle down and use the front brake
- D. Use both brakes at the same time

Answer - page 52

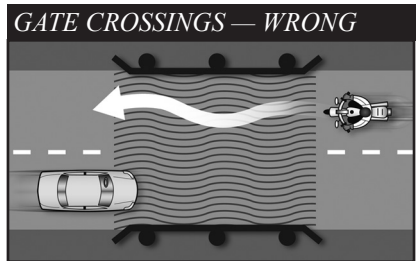
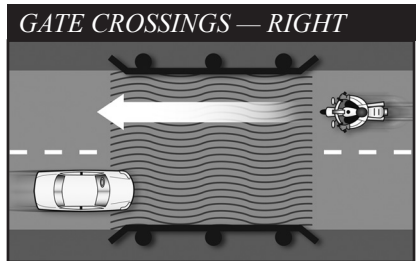

9 *Test Yourself*

When it starts to rain it is usually best to:

- A. Ride in the center of the lane
- B. Pull off to the side until the rain stops
- C. Ride in the tire tracks left by cars
- D. Increase your speed

Answer - page 52

RIDE WITHIN YOUR ABILITIES

Railroad Tracks, Trolley Tracks and Pavement Seams

Usually it is safer to ride straight within your lane to cross tracks. Turning to take tracks head-on (at a 90° angle) can be more dangerous — your path may carry you into another lane of traffic.

For track and road seams that run parallel to your course, move far enough away from tracks, ruts, or pavement seams to cross at an angle of at least 45°. Then, make a deliberate turn. Edging across could catch your tires and throw you off balance.

Grooves and Gratings

Riding over rain grooves or bridge gratings may cause a motorcycle to weave. The uneasy, wandering feeling is generally not hazardous. Relax, maintain a steady speed and ride straight across. Crossing at an angle forces riders to zigzag to stay in the lane. The zigzag is far more hazardous than the wandering feeling.

MECHANICAL PROBLEMS

You can find yourself in an emergency the moment something goes wrong with your motorcycle. In dealing with any mechanical problem, take into account the road and traffic conditions you face. Here are some guidelines that can help you handle mechanical problems safely.

Tire Failure

You will seldom hear a tire go flat. If the motorcycle starts handling differently, it may be a tire failure. This can be dangerous. You must be able to tell from the way the motorcycle reacts. If one of your tires suddenly loses air, react quickly to keep your balance. Pull off and check the tires.

If the front tire goes flat, the steering will feel “heavy.” A front-wheel flat is particularly hazardous because it affects your steering. You have to steer well to keep your balance.

If the rear tire goes flat, the back of the motorcycle may jerk or sway from side to side.

If either tire goes flat while riding:

- **Hold handgrips** firmly, ease off the throttle, and keep a straight course.
- **If braking is required**, gradually apply the brake of the tire that isn't flat, if you are sure which one it is.
- **When the motorcycle slows**, edge to the side of the road, squeeze the clutch and stop.

Stuck Throttle

Twist the throttle back and forth several times. If the throttle cable is stuck, this may free it. If the throttle stays stuck, immediately operate the engine cut-off switch and pull in the clutch at the same time. This will remove power from the rear wheel, though engine sound may not immediately decline. Once the motorcycle is “under control,” pull off and stop.

After you have stopped, check the throttle cable carefully to find the source of the trouble. Make certain the throttle works freely before you start to ride again.

Wobble

A “wobble” occurs when the front wheel and handlebars suddenly start to shake from side to side at any speed. Most wobbles can be traced to improper loading, unsuitable accessories or incorrect tire pressure. If you are carrying a heavy load, lighten it. If you can't, shift it. Center the weight lower and farther forward on the motorcycle.

RIDE WITHIN YOUR ABILITIES

Make sure tire pressure, spring pre-load, air shocks and dampers are at the settings recommended for that much weight. Make sure windshields and check for poorly adjusted steering; worn steering parts; a front wheel that is bent, misaligned, or out of balance; loose wheel bearings or spokes; and worn swingarm bearings. If none of these is determined to be the cause, have the motorcycle checked out thoroughly by a qualified professional.

Trying to “accelerate out of a wobble” will only make the motorcycle more unstable. Instead:

- **Grip the handlebars firmly**, but don’t fight the wobble.
- **Close the throttle gradually** to slow down. Do not apply the brakes; braking could make the wobble worse.
- **Move your weight** as far forward and down as possible.
- **Pull off the road** as soon as you can to fix the problem.

Drive Train Problems

The drive train for a motorcycle uses either a chain, belt, or drive shaft to transfer power from the engine to the rear wheel. Routine inspection, adjustment, and maintenance makes failure a rare occurrence. A chain or belt that slips or breaks while you’re riding could lock the rear wheel and cause your motorcycle to skid.

If the chain or belt breaks, you’ll notice an instant loss of power to the rear wheel. Close the throttle and brake to a stop in a safe area.

On a motorcycle with a drive shaft, loss of oil in the rear differential can cause the rear wheel to lock, and you may not be able to prevent a skid.

Engine Seizure

When the engine “locks” or “freezes” it is usually low on oil. The engine’s moving parts can’t move smoothly against each other, and the engine overheats. The first sign may be a loss of engine power or a change in the engine’s sound. Squeeze the clutch lever to disengage the engine from the rear wheel. Pull off the road and stop. Check the oil. If needed, oil should be added as soon as possible or the engine will seize. When this happens, the effect is the same as a locked rear wheel. Let the engine cool before restarting.

ANIMALS

Naturally, you should do everything you safely can to avoid hitting an animal. If you are in traffic, however, remain in your lane. Hitting something small is less dangerous to you than hitting something big — like a car.

Motorcycles seem to attract dogs. If you are being chased, downshift and approach the animal slowly. As you approach it, accelerate and leave the animal behind. Don’t kick at the animal. Keep control of your motorcycle and look to where you want to go.

For larger animals (deer, elk, cattle) brake and prepare to stop — they are unpredictable.

10

Test Yourself

If your motorcycle starts to wobble:

- A. Accelerate out of the wobble
- B. Use the brakes gradually
- C. Grip the handlebars firmly and close the throttle gradually
- D. Downshift

Answer - page 52

RIDE WITHIN YOUR ABILITIES

FLYING OBJECTS

From time to time riders are struck by insects, cigarettes thrown from cars or pebbles kicked up by the tires of the vehicle ahead. If you are wearing face protection, it might get smeared or cracked, making it difficult to see. Without face protection, an object could hit you in the eye, face or mouth. Whatever happens, keep your eyes on the road and your hands on the handlebars. When safe, pull off the road and repair the damage.

GETTING OFF THE ROAD

If you need to leave the road to check the motorcycle (or just to rest), be sure to:

- **Check the roadside** — Make sure the surface of the roadside is firm enough to ride on. If it is soft grass, loose sand or if you're just not sure about it, slow way down before you turn onto it.
- **Signal** — Drivers behind might not expect you to slow down. Give a clear signal that you will be slowing down and changing direction. Check your mirror and make a head check before you take any action.
- **Pull off the road** — Get as far off the road as you can. It can be very hard to spot a motorcycle by the side of the road. You don't want someone else pulling off at the same place you are.
- **Park carefully** — Loose and sloped shoulders can make setting the side or center stand difficult.

CARRYING PASSENGERS AND CARGO

The extra weight of a passenger or cargo will affect the way your motorcycle behaves, requiring extra practice, preparation and caution. For

this reason, only experienced riders should attempt to carry passengers or large loads. Before taking a passenger or a heavy load on the street, prepare yourself and your motorcycle for safe operation in traffic.

PREPARING YOUR MOTORCYCLE

Tire pressure — Check the air pressure of both tires. Refer to the owner's manual or the label affixed to the motorcycle for the correct inflation specifications. Though most of the added weight will typically be on the rear wheel, don't forget to also check the pressure on the front tire. Correct inflation pressures will maintain maximum stability, steering precision and braking capability.

Suspension — With a heavy load, the riding characteristics and balance of the motorcycle will change. On some motorcycles, it will be necessary to adjust the suspension settings (spring preload, compression/damping settings, etc.) to compensate for the lowered rear of the motorcycle. Refer to the owner's manual for adjustment procedures and specifications.

Headlight — Prior to loading, position the motorcycle about 10 feet from a wall in an unlighted garage and mark the headlight beam location on the wall with chalk. With a full load and passenger, recheck the headlight beam location. Use the adjusting screws on the headlight to lower the beam to the same height. Check your owner's manual for adjustment procedure.

Equipment for Carrying a Passenger

- Be sure your passenger is properly attired, wearing the same level of personal protective gear as you.

RIDE WITHIN YOUR ABILITIES

- Be sure your motorcycle is equipped with passenger footrests.
- Your motorcycle should have a proper seat, one large enough to hold both you and your passenger without crowding. You should not sit more forward than you usually do.
- Check that there is a strap or solid handholds for your passenger to hold onto.

Preparing Your Passenger to Ride

Ensure your passenger is able to reach the passenger footrests, and is able to hold on to your waist, hips, belt, or the bike's passenger handholds. Children should be placed immediately behind the rider. A child sitting in front of the rider will not be able to properly balance him/herself and may interfere with the rider's control of the motorcycle.

Passenger safety begins with proper instruction. Riders should not assume that passengers are familiar with motorcycle handling, control, or balance. As a routine practice, always instruct your passenger on cycling basics prior to starting the trip, even if your passenger is a motorcycle rider.

As you prepare for your ride, tell your passenger to:

- Get on the motorcycle only after you have started the engine and have the transmission in neutral.

As the passenger mounts, keep both your feet on the ground and the brakes applied.

- Sit as far forward as possible without hindering your control of the motorcycle.
- Hold firmly onto your waist, hips, belt or passenger handholds for balance and security.
- Keep both feet firmly on the cycle's footrests, even when stopped. Firm footing will prevent your passenger from falling off and pulling you off.
- Keep legs away from the muffler(s), chains or moving parts.
- Stay directly behind you and lean with you through turns and curves. It is helpful for the passenger to look over the rider's shoulder in the direction of turns and curves.
- Avoid unnecessary conversation and avoid leaning or turning around. Make no sudden moves that might affect the stability of the motorcycle when it is in operation.
- Rise slightly off the seat when crossing an obstacle. Also, remind your passenger to tighten his or her hold when you:
- Approach surface hazards such as bumps or uneven road surfaces.
- Are about to start from a stop or begin moving into traffic.
- Are about to turn sharply or make a sudden move.

11

Test Yourself

If you are chased by a dog:

- A. Kick it away
- B. Stop until the animal loses interest
- C. Swerve around the animal
- D. Approach the animal slowly, then speed up

Answer - page 52

Riding With Passengers

Your motorcycle will respond slowly when you ride with a passenger. The heavier your passenger, the longer it will take to speed up, slow down, or turn.

RIDE WITHIN YOUR ABILITIES

When riding with passengers:

- Ride a little slower, especially when taking curves, corners, or bumps. If any part of the motorcycle scrapes the ground at lean angle, steering control can be lost.
- Start slowing earlier as you approach a stop, and maintain a larger space cushion whenever slowing or stopping.
- Wait for larger gaps to cross, enter, or merge in traffic.

Carrying Loads

Everything you are likely to need for a riding holiday or weekend trip can be packed on your motorcycle in many different ways. There are complete luggage systems, saddlebags that are permanently attached to the motorcycle, soft bags that do not require a carrier system and can be tied to the seat, and a tank bag for other small items. You can also travel simply with only a backpack. Whatever you decide, do not exceed gross vehicle weight rating when traveling with cargo and a passenger, and always make adjustments to the motorcycle to compensate for the added weight.

BEING IN SHAPE TO RIDE

TIPS FOR TRAVELING WITH PASSENGERS AND CARGO

- Keep the load forward. Pack heavier items in the front of the tank bag. Lighter items such as your sleeping bag, ground pad or tent, should be packed on a luggage rack behind you. Try to place the load over, or in front of, the rear axle. Mounting loads behind the rear axle can affect how the motorcycle turns and brakes. It can also cause a wobble.
- Plan your route and length of each day's riding segment and allow plenty of time for breaks. Poor weather, breakdowns, and fatigue are always possible.
- Consider selecting some interesting secondary roads to occasionally reduce the monotony of the highway.
- Start as early in the morning as possible. When you are fresh, you ride at peak performance. For most riders, this is usually between 6 a.m. and 11 a.m. – then, take a good hour's break for lunch. Your energy will pick up again in the afternoon.
- Don't forget sun protection in the summer. Some combinations of riding gear can leave your neck exposed, risking sunburn.
- If you wear a backpack, be sure it is securely attached to you. Try to adjust the shoulder straps so that the backpack rests lightly on the seat. This will reduce the tension in your neck and shoulders.
- If you have a tank bag, be sure it is securely mounted and does not obstruct your view of the controls or instruments. If necessary, pack it only partially full. When strapping the tank bag in place, make sure it does not catch any of the brake lines or cables in the area of the steering head.
- Secure loads low, or put them in saddlebags. Attaching a load to a sissy bar raises the motorcycle's center of gravity and can upset its balance.
- If you use saddlebags, load each with about the same weight. An uneven load can cause the motorcycle to pull to one side. Overloading may also cause the bags to catch in the wheel or chain, locking the rear wheel and causing the motorcycle to skid.
- Fasten the load securely with elastic cords (bungee cords or nets). Elastic cords with more than one attachment point per side are recommended. A loose load could catch in the wheel or chain, causing it to lock up, resulting in a skid. Rope can stretch and knots can come loose, permitting the load to shift or fall. You should stop and check the load often to make sure it has not shifted or loosened.
- Include a small tool kit and some common spare parts that you might need. Water and some energy bars or other food should also be part of your preparation, and don't forget a first aid kit, especially if you are riding in a group.

12

Test Yourself

Passengers should:

- A. Lean as you lean
- B. Hold on to the motorcycle seat
- C. Sit as far back as possible
- D. Never hold onto you

Answer - page 52

BEING IN SHAPE TO RIDE

Pre-Ride Test

Prior to starting out, take a test ride with your fully loaded motorcycle through some familiar neighborhood roads to get a feel for the operation of your motorcycle. Be sure the suspension settings are correct, and that the side stand, footrests, and exhaust pipes don't scrape over bumps and in turns. Ensure the tank bag does not get in the way of the handlebars or restrict the steering. Also check the security of the load, so that your luggage does not hit you in the back under maximum braking.

You will also find that the performance of a fully loaded motorcycle will be different than what you are used to. Test the power when accelerating and be aware that it will be lower, increasing passing times and distances. Braking will also feel different, and stopping distances may increase.

GROUP RIDING

Preparation

Preparing yourself for a group ride is as important as making sure your motorcycle is ready. Riding with a group requires an alert mind that is free from worries, distractions and stress. It also means riding free from the influence of alcohol or drugs. For some, even too much caffeine or prescription drugs can adversely affect concentration.

Prior to a long trip, it's a good idea to have your motorcycle serviced at your local dealership if you aren't able to do the work yourself. A thorough pre-ride check is a must. Use the T-CLOCS checklist as a reminder of the important components to check before you leave. Remember to consider such variables as passengers and extra weight from cargo that might require a change in tire pressure or suspension adjustment.

Plan

Before starting out, hold a rider's meeting to discuss the route, length of riding segments, rest stops and locations for fuel, meals and lodging. Make sure everyone knows the route. That way, if someone becomes separated, he or she won't have to hurry to keep from getting lost or making the wrong turn. Choose a lead rider and a sweep rider. These should be the most experienced riders of the group. The lead rider should look ahead for changes in road, traffic or weather conditions, and signal early so the word gets back in plenty of time to the other riders. The sweep rider is the last rider in the group, and sets the pace for the group. Place inexperienced riders just behind the leader. That ensures that they won't have to chase after the group, and the more experienced riders can watch them from the back.

The most important rules for group riding are: no competition, no passing of other riders and no tailgating. If a rider insists on riding faster than the group, allow him or her to go ahead to an agreed meeting point.

Hand signals

During the rider's meeting, review the hand signals so all riders can communicate during the ride. A diagram of the most common hand signals is at the end of this manual.

Follow those behind

During the ride, use your mirrors to keep an eye on the person behind and confirm that the group is staying together. If a rider falls behind, everyone should slow down to keep the group together.

BEING IN SHAPE TO RIDE

Keep Your Distance

Maintain close ranks, but at the same time, maintain an adequate space cushion to allow each rider in the group time and distance to react to hazards. A close group takes up less space on the highway, is easier to see, and is less likely to become separated. This must, however, be done properly.

Don't Pair Up

Never ride directly alongside another rider in the same lane. There is no place to go if you have to maneuver to avoid a car or hazard in the roadway. Wait until you are both stopped to talk.

Staggered Formation

This is the best way to keep the ranks close yet maintain an adequate space cushion. The group leader rides in the left side of the lane, and the second rider stays at least one second back and rides in the right side of the lane. The third maintains the left position of the lane, at least two seconds behind the first rider. The fourth rider should keep at least a two second distance from the second rider in the right side of the lane, and so on. This formation keeps the group close and permits each rider to maintain a safe distance from others ahead, behind and to the sides.

It is best to move to single file formation when riding in curves, turning, and entering or leaving freeways or highways.

Intersections

Intersections present the highest risk for motorcyclists in a group. When making a left turn at an intersection with a left turn signal arrow, tighten the formation to allow as many riders through the intersection as possible. Make the turn single file – do not ride side-by-side. If not all riders get through the light, stop at a safe point ahead and wait. This will prevent riders from feeling pressured to speed up or run a red light.

Interstate Highways and Freeways

A staggered formation is essential when riding on freeways and interstates. However, enter in single file and form up only after all riders have safely merged in traffic. The lead rider should move the group over at least one lane to prevent vehicles that are entering and exiting from disrupting your formation. In heavy traffic, resist the temptation to ride too close together. Maintain your minimum one-second, two-second staggered formation space cushion. When exiting, use a single file formation for better space cushion and time to react to conditions at the end of the off-ramp.

Parking

When possible, park as a group, so everyone can get off their motorcycles more quickly. Avoid parking downhill or head-in, and if possible, park where you can pull through, making the arrival and departure smoother. Whenever possible, park so that the group can depart as a unit in single file.

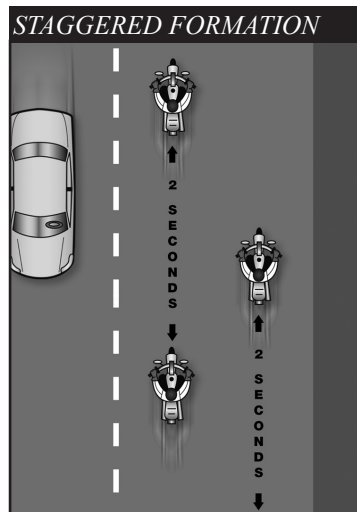

BEING IN SHAPE TO RIDE

Passing in Formation

When the group wants to pass slow traffic on a freeway or interstate, the group may pass as a unit. On a two-lane highway, riders in a staggered formation should pass one at a time.

- First, the lead rider should pull out and pass when it is safe. After passing the leader should return to the left position and continue riding at passing speed to open room for the next rider.
- Next, the second rider should move up to the left position in the lane and wait for a chance to safely pass. When passing be sure you have a clear view of oncoming traffic. Just because the lead rider passed, that does not mean that conditions haven't changed and that it is still safe for other riders to pass. After passing the rider should return to the right position and open up room for the next rider.

Some people suggest that the lead rider should move to the right side of the lane after passing the vehicle. This is not a good idea, since it might encourage the second rider to pass and cut back in before there is enough space cushion in front of the passed vehicle. It's simpler and safer to wait until there is enough room ahead of the passed vehicle to allow each rider to move into the same position held before the pass.

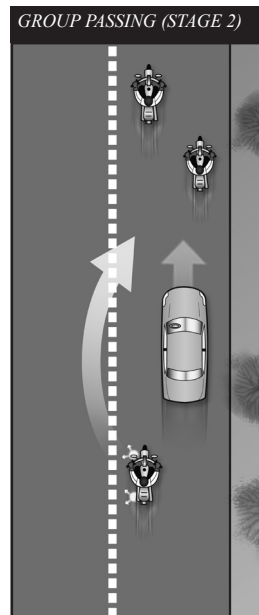
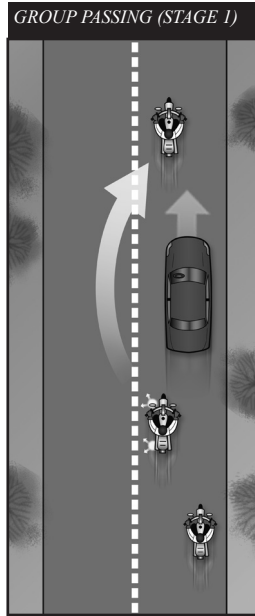

13

Test Yourself

When riding in a group, inexperienced riders should position themselves:

- A. Just behind the leader
- B. In front of the group
- C. At the tail end of the group
- D. Beside the leader

Answer - page 52

BEING IN SHAPE TO RIDE

Ten Rules of Group Riding

- Base the length of the route and segments on ability of the least experienced rider.
- Take timely breaks to prevent loss of concentration and reduce fatigue.
- Adjust the pace through curves to the ability of the least experienced rider. If necessary, form two groups with different speeds.
- Don't tailgate or encourage the rider in front to speed. If you want to ride faster, ride ahead of the group.
- Keep adequate following distance and maintain a staggered formation.
- Do not pass in the group, except in the case of emergency.
- Place inexperienced riders just behind the leader so they can keep pace without riding faster than it is safe.
- When passing, be conscious of the traffic conditions and oncoming traffic. Even though the previous riders passed safely, it may not be safe for you.
- Maintain adequate time distance between riders, especially at intersections. This allows you to avoid hard braking.
- Check your mirrors frequently to ensure the group stays together.

BEING IN SHAPE TO RIDE

Riding a motorcycle is a demanding and complex task. Skilled riders pay attention to the riding environment and to operating the motorcycle, identifying potential hazards, making good judgments and executing decisions quickly and skillfully. Your ability to perform and respond to changing road and traffic conditions is influenced by how fit and alert you are. Alcohol and drugs, more than any other factor, degrade your ability to think clearly and to ride skillfully. As little as one drink can have a significant effect on your performance.

Let's look at the risks involved in riding after drinking or using drugs. What to do to protect yourself and your fellow riders is also examined.

WHY THIS INFORMATION IS IMPORTANT

Alcohol is a major contributor to motorcycle crashes, particularly fatal crashes. Studies show that 29% of all fatally injured motorcycle riders had BAC levels above the legal limit of 0.08%. An additional 8% had lower alcohol levels (BAC 0.01 to 0.07%), demonstrating that having only a drink or two in one's system is enough to impair riding skills. Drug levels are harder to distinguish or have not been separated from drinking violations for the traffic records. But riding "under the influence" of either alcohol or drugs poses physical and legal consequences for every rider.

Drinking and drug use is as big a problem among motorcyclists as it is among automobile drivers. Motorcyclists, however, are more likely to be killed or severely injured in a crash. Injuries occur in 90% of motorcycle crashes and 33% of automobile crashes that involve abuse of substances. On a yearly basis, 2,000 motorcyclists are killed and about 50,000 seriously injured in this same type of crash. These statistics are too overwhelming to ignore.

By becoming knowledgeable about the effects of alcohol and drugs you will see that riding and substance abuse don't mix. Take positive steps to protect yourself and prevent others from injuring themselves.

ALCOHOL AND DRUGS IN MOTORCYCLE OPERATION

No one is immune to the effects of alcohol or drugs. Friends may brag about their ability to hold their liquor or perform better on drugs, but alcohol or drugs make them less able to think clearly and perform physical tasks skillfully. Judgment and the decision-making processes needed for vehicle operation are affected long before legal limits are reached.

Many over-the-counter, prescription and illegal drugs have side effects that increase the risk of riding. It is difficult to accurately measure the involvement of particular drugs in motorcycle crashes. But we do know what the effects of various drugs have on the processes involved in riding a motorcycle. We also know that the combined effects of alcohol and drugs are more dangerous than either is alone.

ALCOHOL IN THE BODY

Alcohol enters the bloodstream quickly. Unlike most foods and beverages, it does not need to be digested. Within minutes after being consumed, it reaches the brain and begins to affect the drinker. The major effect alcohol has is to slow down and impair bodily functions — both mental and physical. Whatever you do, you do less well after consuming alcohol.

BEING IN SHAPE TO RIDE

Blood Alcohol Concentration

Blood Alcohol Concentration or BAC is the amount of alcohol in relation to blood in the body. Generally, alcohol can be eliminated in the body at the rate of almost one drink per hour. But a variety of other factors may also influence the level of alcohol retained. The more alcohol in your blood, the greater the degree of impairment.

Three factors play a major part in determining BAC:

- **The amount** of alcohol you consume.
- **How fast** you drink.
- **Your body** weight.

Other factors also contribute to the way alcohol affects your system.

Your sex, physical condition and food intake are just a few that may cause your BAC level to be even higher. But the full effects of these are not completely known. Alcohol may still accumulate in your body even if you are drinking at a rate of one drink per hour. Abilities and judgment can be affected by that one drink.

A 12-ounce can of beer, a mixed drink with one shot (1.5 ounces) of liquor, and a 5-ounce glass of wine all contain the same amount of alcohol.

The faster you drink, the more alcohol accumulates in your body. If you drink two drinks in an hour, at the end of that hour, at least one drink will remain in your bloodstream.

Without taking into account any other factors, these examples illustrate why time is a critical factor when a rider decides to drink.

If you drink:

– Seven drinks over the span of three hours you would have at least four ($7 - 3 = 4$) drinks remaining in your system at the end of the three hours. You would need at least another four hours to eliminate the four remaining drinks before you consider riding.

– Four drinks over the span of two hours would have at least two drinks remaining in their system at the end of the two hours ($4 - 2 = 2$). They would need at least another two hours to eliminate the two remaining drinks before they consider riding.

Total drinks consumed	<i>LESS</i>	# Hours since last drink	<i>EQUALS</i>	Drinks left in body
_____	-	_____	=	_____

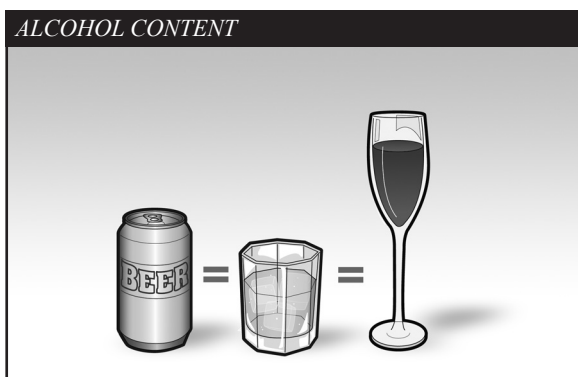

BEING IN SHAPE TO RIDE

ALCOHOL AND THE LAW

In all states, an adult with a BAC of .08% or above is considered intoxicated. For operators under the age of 21, lower BAC limits (0.00 to 0.02%, depending on state) apply. It doesn't matter how sober you may look or act. A breath, blood, or urine test is what usually determines whether you are riding legally or illegally. Whether or not you are legally intoxicated is not the real issue. Impairment of judgment and skills begins well below the legal limit.

Your chances of being stopped for riding under the influence of alcohol are increasing. Law enforcement is being stepped up across the country in response to the senseless deaths and injuries caused by drinking drivers and riders.

ALCOHOL AND OHIO'S LAW

Sweeping reforms of Ohio's drunk driving laws went into effect in 2004. The new laws make it tougher for drivers who make the wrong decision to drink or use drugs and get behind the wheel of a vehicle.

CONSEQUENCES OF CONVICTION

If you are convicted of riding under the influence of alcohol or drugs, you may receive any or all of the following penalties:

1st Offense

- Administrative License Suspension (ALS) for 90 days for .08% or above BAC
- ALS for test refusal = one-year license suspension
- Jail: minimum of three consecutive days or three-day intervention program¹

- Fine: minimum \$375 and not more than \$1,075
- Court License Suspension: six months to three years

2nd Offense

- ALS for one year for .08% or above BAC
- ALS for 2nd test refusal = two-year license suspension
- Jail: minimum of 10 consecutive days or five days jail + minimum 18 consecutive days of electronically monitored house arrest combined, not to exceed six months¹
- Fine: minimum \$525 and not more than \$1,625
- Mandatory drug and alcohol assessment
- Vehicle immobilization and plates impounded for 90 days, if owner
- Court License Suspension: one year to five years

¹ Doubled on conviction of .17% BAC and Operating a Vehicle Impaired (OVI)/refusal

3rd Offense

- ALS for two years for .08% or above BAC
- ALS for 3rd test refusal = three-year license suspension
- Jail: minimum 30 consecutive days to one year
- Alternative sentence: 15 days of jail + minimum 55 consecutive days of electronically monitored house arrest combined, maximum of one year
- Fine: minimum \$850 and not more than \$2,750
- Mandatory attendance in an alcohol treatment program paid for by offender

BEING IN SHAPE TO RIDE

- Vehicle forfeiture will result upon a 3rd conviction for OVI within six years, if owner
- Court License Suspension: two years to 10 years

4th or More Offense or motor vehicle-related felony will result in vehicle forfeiture, if owner, and stricter penalties.

- Any previous OVI conviction that was a felony = a minimum of \$1,350 and not more than \$10,500
- 5th or subsequent OVI offense on or after September 30, 2008 will be placed on “Ohio’s Habitual OVI/OMVI Offender Registry.” This registry becomes accessible to the public, via the internet, on December 30, 2008.

MINIMIZE THE RISKS

Your ability to judge how well you are riding is affected first. Although you may be performing more and more poorly, you think you are doing better and better. The result is that you ride confidently, taking greater and greater risks. Minimize the risks of drinking and riding by taking steps before you drink. Control your drinking or control your riding.

Make an Intelligent Choice

Don’t Drink — Once you start, your resistance becomes weaker.

Setting a limit or pacing yourself are poor alternatives at best. Your ability to exercise good judgment is one of the first things affected by alcohol. Even if you have tried to drink in moderation, you may not realize to what extent your skills have suffered from alcohol’s fatiguing effects.

Or Don’t Ride — If you haven’t controlled your drinking, you must control your riding.

- Leave the motorcycle — so you won’t be tempted to ride. Arrange another way to get home.
- Wait — If you exceed your limit, wait until your system eliminates the alcohol and its fatiguing effects.

STEP IN TO PROTECT FRIENDS

People who have had too much to drink are unable to make a responsible decision. It is up to others to step in and keep them from taking too great a risk. No one wants to do this — it’s uncomfortable, embarrassing and thankless. You are rarely thanked for your efforts at the time. But the alternatives are often worse.

There are several ways to keep friends from hurting themselves:

- **Arrange a safe ride** — Provide alternative ways for them to get home.
- **Slow the pace of drinking** — Involve them in other activities.
- **Keep them there** — Use any excuse to keep them from getting on their motorcycle. Serve them food and coffee to pass the time. Explain your concerns for their risks of getting arrested or hurt or hurting someone else. Take their key, if you can.
- **Get friends involved** — Use peer pressure from a group of friends to intervene.
It helps to enlist support from others when you decide to step in.

BEING IN SHAPE TO RIDE

The more people on your side, the easier it is to be firm and the harder it is for the rider to resist. While you may not be thanked at the time, you will never have to say, “If only I had ...”

MARIJUANA AND MOTORCYCLE OPERATION

Marijuana is gaining acceptance as having legitimate medicinal applications and as a recreational drug in the United States, as evidenced by recent trends in state laws permitting its use. As of early 2014, 20 states allowed marijuana for medical use, and two allowed it for recreational use by people 21 and over.

Although marijuana may be legal for medicinal or recreational use in your state, it is still not legal, safe, or wise to operate a motor vehicle while impaired by marijuana, since it tends to distort your perception of time, space and speed. This is especially critical for motorcycle riders, who must continually make detailed assessments of complex traffic situations and make split-second decisions requiring precise rider input to navigate safely and maintain an adequate safety margin.

States are beginning to set marijuana impairment limits based on blood content levels of marijuana’s primary psychoactive ingredient, THC. However, compared to alcohol and BAC level, it is difficult to determine the relationship between the amount of marijuana ingested and the resulting THC level in the blood. Complicating factors include marijuana’s potency, which is highly variable, and ingestion method, which has significant bearing on the onset and duration of impairment.

When marijuana is smoked, its effects generally begin within a few minutes and can last from 2 to 4 hours. But when marijuana is eaten the onset of effects could be delayed for more than an hour and the duration of the “high” could be more than 6 hours.

Be safe. Do not operate your motorcycle or any motor vehicle if you are impaired by marijuana, and find alternate transportation if you are planning to be under the influence of marijuana at your destination. Just as with alcohol, riders impaired by marijuana can be convicted of riding under the influence, and be subjected to similar harsh penalties.

FATIGUE

Riding a motorcycle is more tiring than driving a car. On a long trip, you’ll tire sooner than you would in a car. Avoid riding when tired. Fatigue can affect your control of the motorcycle.

- **Protect yourself** from the elements — Wind, cold, and rain make you tire quickly. Dress warmly. A windshield is worth its cost if you plan to ride long distances.
- **Limit your distance** — Experienced riders seldom try to ride more than about six hours a day.

14

Test Yourself

If you wait an hour for each drink before riding:

- A. You cannot be arrested for drinking and riding.
- B. Your riding skills will not be affected.
- C. Side effects from the drinking may still remain.
- D. You will be okay as long as you ride slowly.

Answer - page 52

BEING IN SHAPE TO RIDE

- **Take frequent rest breaks** — Stop and get off the motorcycle at least every two hours.
- **Don't drink or use drugs** — Artificial stimulants often result in extreme fatigue or depression when they start to wear off. Riders are unable to concentrate on the task at hand.

THREE-WHEEL SUPPLEMENT

SUPPLEMENTARY INFORMATION FOR THREE- WHEEL MOTORCYCLES

Many states require a separate license endorsement to operate a three-wheel motorcycle. This requires the rider to pass both a written and a skills test. The purpose of this supplement is to help prepare riders to complete the written exam for a three-wheel motorcycle license or endorsement. This information is provided in addition to that offered in the first part of this Motorcycle Operator Manual (MOM), so when preparing to take the written test, begin by reading the information on two-wheel motorcycles thoroughly. It provides information on safe operation of your motorcycle in traffic. This supplement contains information specific to the safe operation of a three-wheel motorcycle, including both three-track motorcycles and motorcycles with sidecars.

KNOW YOUR VEHICLE

There are many types of three-wheel motorcycles available on the market today. Requirements for licensing three-wheel motorcycles vary by state. In general, three-wheel motorcycles will have the following characteristics:

1. **Three wheels** leaving two or three separate tracks during straight line operation.
 2. **Motorcycle-based** conversion or design with:
 - Handlebar steering
 - Motorcycle-type controls with the standard layout. Convenience alterations like a single brake pedal or lever control, automatic clutch, or automatic transmission.
 - Saddle seating
 - Seating in which the rider/passenger straddles the vehicle.
 - If designed for a passenger, the passenger must be seated behind the operator (or in a separate passenger compartment in the case of a motorcycle with sidecar).
 3. **Turning diameter** of the vehicle at its widest point must be less than 40’.
 4. **The vehicle** meets all applicable federal on-road vehicle standards.
- The following vehicles are not included in this definition, and therefore testing requirements may not be applicable. Always refer to your state Department of Motor Vehicles, Department of Licensing or other appropriate state regulatory agency for exact regulations regarding testing for:
- **Automotive hybrids** or automotive conversions
 - **Vehicles with automotive** controls or seating
 - **Vehicles with front or rear mounted engines** (engines must be mounted mid-frame below the rider to be considered motorcycle-based)
 - **Vehicles with enclosed** or semi-enclosed riding compartments
 - **Motorcycles or scooters** with two close-set wheels in front (contact patches less than 18.1 inches apart) that lean and maneuver like standard, single-track, two-wheel motorcycles or
 - **Vehicles** with any other departure from the above standards.

THREE-WHEEL SUPPLEMENT

Three-Wheel Motorcycle Designs

Three-wheel motorcycle designs vary among manufacturers. Unlike traditional motorcycles, which are considered single-track motorcycles, three-wheel motorcycles could be either dual or triple track design. Dual track vehicles are motorcycles with sidecars, while triple track motorcycles can be configured either with dual front wheels or dual rear wheels.

MOTORCYCLE AND THREE-WHEEL MOTORCYCLE DESIGNS

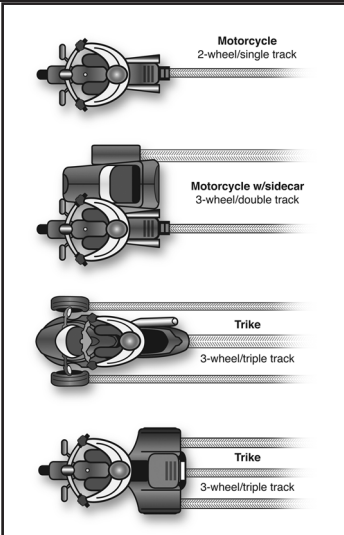

The Right Motorcycle for You

Make sure your three-wheel motorcycle or sidecar-equipped motorcycle is right for you. You should be able to comfortably reach and operate all of the controls, and be able to complete full turns using the handlebars without excessive upper body movements that could jeopardize stability and control.

Borrowing and Lending

Borrowers and lenders, beware.

Crashes are more likely to occur among beginning operators, especially in the first months of riding. Operating an unfamiliar motorcycle adds to the problem. If you borrow a three-wheel motorcycle or motorcycle with sidecar, get familiar with it in a controlled area first. If you lend your three-wheel motorcycle or motorcycle with sidecar to friends, make sure they are licensed and know how to ride before you allow them to operate in traffic. Such motorcycles operate very differently than two-wheel motorcycles.

No matter how experienced you may be, be extra careful on any vehicle that is unfamiliar or new to you.

Get Familiar with Motorcycle Controls

Be sure you are familiar with the controls of the three-wheel motorcycle or motorcycle with a sidecar before attempting to operate it on any highway, since some controls may differ from those found on other motorcycles. This is especially important if you are riding on a borrowed motorcycle. Before beginning the ride:

- **Make all the checks** you would on your own motorcycle.
- **Familiarize yourself** with all controls, such as the turn signals, horn, headlight switch, fuel control valve, and cut-off switch. Locate and operate these items without having to search for them.

THREE-WHEEL SUPPLEMENT

- Operate all the controls before you start riding. Know the gearshift pattern and operate the throttle, clutch and brakes a few times. Controls react differently on different motorcycles, and exact locations of controls may vary slightly. Additionally, some motorcycle conversions may be equipped with a single brake pedal or lever control, automatic clutch, or automatic transmission.
- As you begin to ride, start out slowly and carefully and be aware of your surroundings. Accelerate gently, take turns a little more slowly, and leave extra room for stopping.

BASIC VEHICLE CONTROL

Steering & Tip

Three-wheelmotorcycles handle differently than two-wheel motorcycles. With three wheels on the ground, they are naturally more stable than a two-wheel motorcycle. They also steer differently. Because conventional three-wheel motorcycles cannot lean, they cannot countersteer. Instead, the front wheel is pointed in the direction the rider wants the motorcycle to go.

Under some conditions during the operation of a three-wheel motorcycle, it is possible to have only two wheels in contact with the road surface. This

could occur during turning or tight maneuvers whenever enough weight is transferred outside of what are called tip-over lines. This tendency requires careful load and passenger positioning inside the tip-over lines to help maintain maximum stability.

Body Position

As with any motor vehicle, operator position is important for control and for reducing or preventing fatigue. The operator should be able to reach both handgrips comfortably, since more handlebar movement is necessary than when riding a two-wheel motorcycle. While it is not necessary for the rider of a three-wheel motorcycle to move drastically during operation, shifting weight in the direction of the turn can improve control.

Braking

On a motorcycle with a sidecar, during braking in a sharp turn, the sidecar wheel may lift off the ground. Motorcycle and sidecar tires have limited traction or grip on the road surface, and traction is greater when the motorcycle is rolling, not skidding or slipping. During turning, some of the available tire traction is used for cornering, so less is available for stopping. Thus, a skid can occur if you brake too hard.

Turning

The tendency of the rear inside wheel to lift during turning is greater with increased speed and tighter curve radii. During a turn, inertia causes the center of gravity of the motorcycle to shift sideways and outward toward the tip-over line. The reduced weight over the opposite side wheel can cause it to lift slightly.

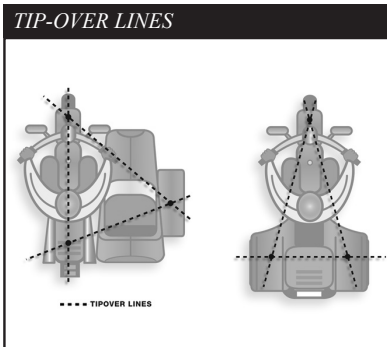

THREE-WHEEL SUPPLEMENT

The weight of a three-track motorcycle is distributed almost equally between the two front or two rear wheels. These motorcycles handle the same in left and right hand turns.

When turning a three-track motorcycle:

- **Approach a turn** at speed with your head up, and look through the turn.
- **Concentrate** on pointing the front wheel/wheels in the direction you want the motorcycle to go.
- **Roll off** the throttle before entering the turn.
- **Apply the brakes** enough to slow the motorcycle to a speed at which you can ride safely through the turn, then release the brakes before the turn.
- **Slightly lean** your upper body in the direction you intend to turn.
- **Steer** the front wheel/wheels toward the turn.
- **Roll on** the throttle to pull the motorcycle through the turn.

On the other hand, because the center of gravity of a motorcycle with sidecar is close to the motorcycle itself, the behavior of the vehicle when turning right and when turning left is quite different.

During a right turn, a slight sideways movement of the center of gravity creates a greater tendency for the sidecar wheel to lift. The lift will be greater if the sidecar is empty or lightly loaded.

When turning right on a motorcycle with sidecar:

- **Anticipate** the degree of turn required.

- **Reduce speed** before entering the curve by downshifting or braking.
- **Slightly lean** your upper body in the direction you intend to turn.
- **Maintain speed** as you enter the curve.
- **Accelerate** gradually as you exit the curve.

During a left hand turn, the sidecar acts as a stabilizer, so the sidecar wheel stays on the ground. However, if the turn is taken too sharply or at too high a rate of speed, there is a tendency for the motorcycle rear suspension to extend, and this may cause the rear wheel of the motorcycle to lift off the ground.

When turning left on a motorcycle with sidecar:

- **Reduce** speed prior to entering the turn
- **Apply** more pressure on the rear brake then on the front

Hills

When riding uphill on a three-wheel motorcycle or motorcycle with a sidecar, some weight will shift to the rear, causing the front of the motorcycle to become lighter. This weight shift reduces the traction on the front tire/tires for steering and tire grip.

When riding downhill, gravity increases the amount of braking force required to slow or stop the motorcycle. It is important, therefore, to begin slowing earlier for cornering and stopping.

THREE-WHEEL SUPPLEMENT

Lane Position

The track of the dual wheels of a three-wheel motorcycle or motorcycle with a sidecar is almost the same width as some automobiles. Unlike a motorcycle, you are limited, therefore, in lane positioning. Keep toward the center of the lane to be sure the track of the dual wheels does not cross the painted lines into opposing traffic. Riding too far to the right could cause loss of traction if the tire leaves the pavement.

Lane positioning when riding in groups is also an important consideration. You will not be able to use a staggered formation, such as you would when riding two-wheeled motorcycles. Ride single file and always maintain a safe margin, two seconds minimum, between vehicles.

Parking at the Roadside

Because of the limitations on mobility and motorcycle length, it is not practical to park your motorcycle at a 90 degree angle with your rear wheel touching the curb, as you would with a two-wheel motorcycle. Position your motorcycle in a parking space so you are parked parallel to the curb and set the parking brake. Some three-wheel motorcycles have reverse, so you can more easily maneuver into a parking space designed for an automobile. Parking parallel to the curb will facilitate pulling away from the curb and entering the lanes of traffic.

Acceleration and Deceleration

A three-wheel motorcycle with two drive wheels tends to be much more stable during acceleration and braking than a motorcycle with a sidecar. Attaching a sidecar to your motorcycle adds a non-powered, off-centered mass of weight. So, during acceleration, the sidecar will feel as though it is lagging behind

you, causing the vehicle to feel as though it is being steered to the right. During deceleration or braking, the momentum of the sidecar continues to carry it forward, giving the feeling that the sidecar is trying to pass you, making the motorcycle feel as though it is being steered left.

- **On acceleration**, compensate for this tendency by steering slightly in the opposite direction from the sidecar.
- **On deceleration**, compensate for this tendency by steering slightly in the direction of the sidecar. You can also pull in the clutch when braking.

Swerving

A quick stop may not always be sufficient to avoid an obstacle in your path, even if you properly apply both brakes. Sometimes the only way to avoid a collision is to swerve. A swerve is any sudden change of direction. It can be two quick turns or a rapid shift to the side when maneuvering the motorcycle. Often, there is not much time to adjust your body position.

A three-wheel motorcycle or motorcycle with sidecar is not as maneuverable as a two-wheel motorcycle, so plan well ahead to avoid the need for any sudden turns or swerving. If braking is required, brake either before or after the swerve, never while swerving.

Cornering & Curves

The cornering characteristics of a three-wheel motorcycle or motorcycle with a sidecar differ from those of a motorcycle. Even with three wheels on the ground, a sidecar can tip over if it is being turned too sharply or is going too fast for a corner. Therefore, it is best to always slow before entering a corner.

THREE-WHEEL SUPPLEMENT

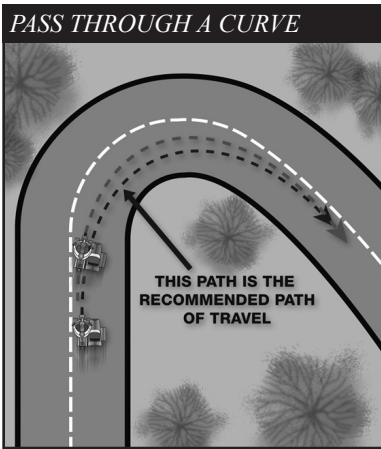

The best path to follow in the curve may not be the one that follows the curve of the road. Following the center of the lane may actually increase the tip over forces. Check opposing traffic carefully, and if safe, enter the curve toward the outside of your lane. This increases your line of sight through the curve and reduces the effective radius of the curve. As you turn, move toward the inside of the curve, and as you pass the center, move to the outside to exit, always remembering to stay in your lane.

CARRYING PASSENGERS AND CARGO

Three-wheel motorcycles are designed to carry passengers and cargo, but always be sure not to exceed the tire or motorcycle loading capacity. The extra weight could change the handling characteristics of the vehicle slightly, so you must give some thought to where the loads are positioned.

Many three-track motorcycles will have built-in storage compartments for cargo, either in front of, or behind the rider. On these motorcycles, center the load and keep it low in the storage areas so it is positioned within the tip-over lines and balanced side-to-side. If a

passenger is being carried, the passenger will sit directly behind the rider.

On a motorcycle with a sidecar, the best place for a passenger is in the sidecar. Never put a single passenger on the saddle; the added weight on the tip-over-line will increase the instability of the motorcycle. While a second passenger can be carried on the seat behind the rider, the heavier passenger should always be in the sidecar.

The passenger sitting behind the rider should sit upright at all times. It is not necessary for the passenger to lean into curves with the rider.

When carrying loads in a sidecar, secure the load firmly in place, since if the load shifts, handling will be affected. Loads should be distributed toward the rear of the sidecar to reduce tipping of the nose of the sidecar in the event of a sudden left turn.

When loaded, you may find performance is reduced and that stopping distances are longer, so allow a little extra distance. The addition of a sidecar passenger will greatly improve stability, and right hand turns can be made at a slightly higher speed. Turning left, however, will require more turning force.

ANSWERS TO QUESTIONS

1. A plastic shatter-resistant face shield:

- C. Helps protect your whole face

2. More than half of all crashes:

- D. Involve riders who have ridden their motorcycles less than six months

3. When riding, you should:

- D. Turn just your head and eyes to look where you are going

4. Usually, a good way to handle tailgaters is to:

- A. Change lanes and let them pass

5. To reduce your reaction time, you should:

- B. Cover the clutch and the brakes

6. Making eye contact with other drivers:

- C. Doesn't mean that the driver will yield

7. Reflective clothing should:

- A. Be worn at night

8. The best way to stop quickly is to:

- D. Use both brakes at the same time

9. When it starts to rain it is usually best to:

- C. Ride in the tire tracks left by cars

10. If your motorcycle starts to wobble:

- C. Grip the handlebars firmly and close the throttle gradually

11. If you are chased by a dog:

- D. Approach the animal slowly, then speed up

12. Passengers should:

- A. Lean as you lean

13. When riding in a group, inexperienced riders should position themselves:

- A. Just behind the leader

14. If you wait an hour for each drink before riding:

- C. Side effects from the drinking may still remain.

HAND SIGNALS

1

Single File - arm and index finger extended strating up.



2

Double File - arm and index and middle finger extended strating up.



3

Stop - arm extended straight down, palm facing back.



4

Speed Up - arm extended straight out, palm facing up, swing upward.



5

Slow Down - arm extended straight out, palm facing down, swing down to your side.



6

Follow Me - arm extended straight up from shoulder, palm forward.



7

You Lead/Come - arm extended upward 45 degrees, palm forward pointing with index finger, swing in arc back to front.



HAND SIGNALS

- 8** **Hazard in Roadway** - on the left, point with left hand; on the right, point with right foot.

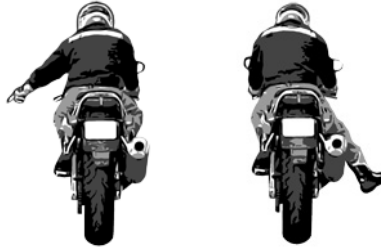

- 9** **Highbeam** - tap on top of helmet with open palm down.



- 10** **Fuel** - arm out to side pointing to tank with finger extended.



- 11** **Comfort Stop** - forearm extended, fist clenched with short up and down motion.



- 12** **Refreshment Stop** - fingers closed, thumb to mouth.



- 13** **Turn Signal On** - open and close hand with fingers and thumb extended.



- 14** **Pull Off** - arm positioned as for right turn, forearm swung toward shoulder.

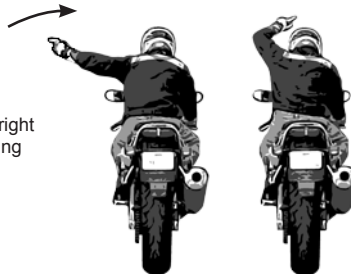

You can tear this page out and keep it with you when you ride.

T-CLOCS: Pre-Ride Inspection Checklist

T-CLOCS ITEM	WHAT TO CHECK	WHAT TO LOOK FOR	CHECK-OFF
T-TIRES & WHEELS			
Tires	Conditions Air Pressure AF Pressure	Insufficient wear, weathering, uneven wear, bulges, embedded objects. Checks when cold, adjust to load.	front rear
Wheels	Spokes COT GAT	Back, broken, missing, tension, check top of wheel: "ring", "OK" — "thud" — loose spoke Cracks, dents.	front rear
Brakes	Rims Rimcap Sprockets	Out of round true = shim. Sprockets index against castings & pistons. Grating and chattering (if red and blue, no freewheel clicks) between hub and disk no gravel in freewheeling. Cracked, cut or worn, over the groove or outside, or dished, become round table.	front rear front rear
C-CHASSIS	Function	Each bolt/ nut keeps bike from falling.	front rear
C-CONTROLS	Conditions Pivots Peaks	Bolts kept coated, mounts tight, but not on handlebar levers, a gear adjustment. Lubricated.	
Levers and Pedal	Conditions Pivots Peaks	Frays, leaks, lubrication tank sufficient.	
Cables	Routing Conditions	No interference or rubbing at junctions, bad supports, no sharp angles, wire appears to pull. Get, cracks, leaks, bulges, safety, electrical contacts.	
Handle	Routing Conditions	No interference or rubbing at junctions, bad supports, no sharp angles, wire appears to pull. Always keep rings locked, no moving parts, hub checks are correct.	
Throttle	Operation		
L-LIGHTS	Conditions	Front, back, down and up light, accessory not, had down assembly.	
Battery	Front fender Conditions Aim	Not blocked, cover properly, not plugged. Checks reflector, mounting and adjustment system. Height and light level.	
Headlamp	Operation	High beam low beam operation.	
Tail lamp/ brake lamp	Conditions	Cracks, clean and tight.	
Turn signals	Operation	Activate upon front brake cover or brake application. Flashes correct.	front left front right
Mirrors	Conditions	Cracks, clean, light mounts and dowel joints.	
Lenses & Reflectors	Aim Conditions	Aiming when seated on bike. Correct, broken, severely mounted, excessive condensation.	
Wiring	Conditions Routing	Fraying, dangling, insulation. Protected, no interference or rubbing at steering head or suspension, wire broken and ties in place, connections tight, clean.	
O-OIL			
Levels	Engine Oil Hydro Gear Oil Hydraulic fluid Coolant Fuel	Checks warm on contact on level ground, dipstick, sight glass. Transmission, run or drive, shift. Bubbles, clutch, reservoir or sight glass. Reservoir and/or coolant reservoir full — check only when cool. Correct	
Leaks	Engine Oil Hydraulic fluid Coolant Fuel	Leaks, hoses, seals. Leaks, master cylinders, calipers. Balance hoses, tanks, fittings, spigots. Leaks, back valve carbs.	

EMERGENCY INFORMATION

Rider's Name _____ Blood Type _____

Allergies/Medical Conditions _____

Doctor's Name/Phone _____

Cycle Insurer Name/Phone _____

Contact this person if rider is injured _____

Name _____ Home Phone _____

Work Phone _____ Cell Phone _____

MOTORCYCLES MAKE SENSE – SO DOES PROFESSIONAL TRAINING

Motorcycles are inexpensive to operate, fun to ride and easy to park. Unfortunately, many riders never learn critical skills needed to ride safely.

Professional training for beginning and experienced riders prepares them for real-world traffic situations. An approved state rider education class can teach and improve such skills as:

- Effective turning
- Braking maneuvers
- Protective apparel selection
- Obstacle avoidance
- Traffic strategies
- Maintenance

For the beginning or experienced course nearest you, visit www.Motorcycle.Ohio.Gov, email the motorcycle ohio office at: mogen@dps.ohio.gov, or call toll free: 1-800-83-RIDER.

Portions of this manual courtesy of

Ohio

**Bureau of
Motor Vehicles**

***Motorcycle*Ohio**



Motorcycle Safety Foundation
2 Jenner Street, Suite 150, Irvine CA 92618-3806
<http://www.msf-usa.org>

NOTES

NOTES

NOTES

Ohio

Bureau of Motor Vehicles

Motorcycle Ohio



www.OPLATES.com
1-866-OPLATES

Ohio

Department of Public Safety

www.publicsafety.ohio.gov
An Equal Opportunity Employer
MOP 0001 1/22 [760-1109]